

GENERAL CATALOG |

MIG/MAG
TIG
ACCESSORIES

VERSION 2.3



Manual Welding Technology for all Metalworking Industries



You can find the latest extraction technology products in our xFUME® catalog!

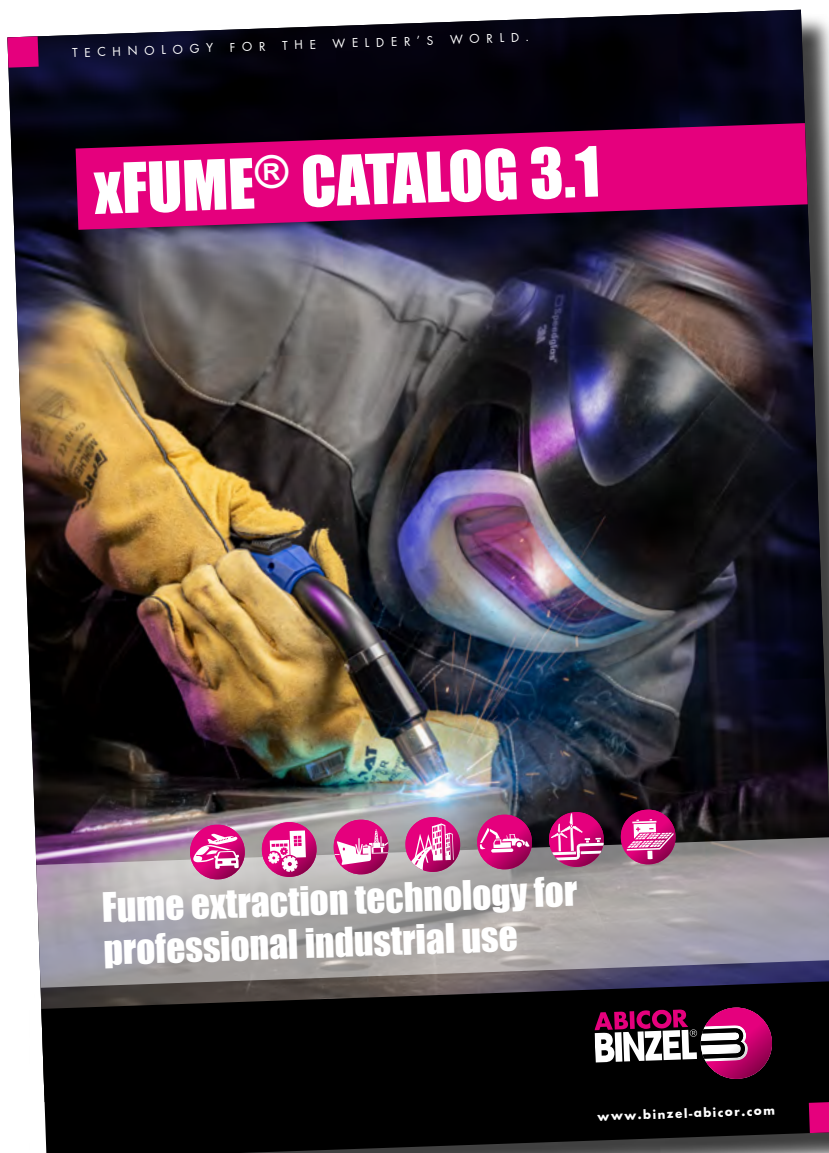

CONTENTS GENERAL CATALOG

FROM PAGE

MIG/MAG

5



TIG

94



ACCESSORIES























160





MIG/MAG

CONTENTS MIG/MAG

		COOLING	RATING	FROM PAGE	
SYSTEM MB FROM PAGE 6	MB EVO PRO 15 / 15 FLEX ■ MB EVO PRO 25 / 25 FLEX		150–230 A	8	
	MB EVO PRO 24 ■ MB EVO PRO 26 MB EVO PRO 36		220–320 A	10	
	MB EVO PRO 240 D ■ MB EVO PRO 401 D MB EVO PRO 501 D		300–550 A	12	
	MB EVO 15 ■ MB EVO 25		150–230 A	16	
	MB EVO 24 ■ MB EVO 36		220–320 A	18	
	MB EVO 240 D ■ MB EVO 401 D MB EVO 501 D		270–500 A	20	
	ABIMIG® GRIP W 555 D ABIMIG® GRIP W 555 D TS		400–550 A	24	
	SYSTEM ABIMIG® FROM PAGE 26	ABIMIG® A T 155 LW ■ ABIMIG® A T 255 LW		180–240 A	28
		ABIMIG® A T 305 LW ■ ABIMIG® A T 355 LW ABIMIG® A T 405 LW		260–400 A	30
		ABIMIG® A T 155 S LW ■ ABIMIG® A T 255 S LW ABIMIG® A T 355 S LW		160–320 A	32
ABIMIG® A 155 LW ■ ABIMIG® A 255 LW			170–320 A	36	
ABIMIG® A 305 LW ■ ABIMIG® A 355 LW ABIMIG® A 405 LW			260–400 A	38	
ABIMIG® W T 340 ■ ABIMIG® W T 440 ABIMIG® W T 540			350–550 A	42	
ABIMIG® W 340 ■ ABIMIG® W 440 ABIMIG® W 540			350–550 A	46	
MACHINE TORCHES		FIXED TORCH NECK	 	220–550 A	50
		CHANGEABLE TORCH NECK	 	220–550 A	51
PUSH-PULL PLUS		PP PLUS 36 D ■ PP PLUS 401 D	 	270–400 A	54
FREEDOMDRIVE	ABIMIG® A 355 LW ■ ABIMIG® A T 355 LW		310–340 A	58	
	ABIMIG® W 540 ■ ABIMIG® W T 540		450–500 A	60	
FLUX	ALPHA FLUX 350		330 A	62	
ACCESSORIES & SPECIAL EQUIPMENT MIG/MAG	LINERS			68	
	CONTACT TIPS			70	
	FOR ABIMIG® A & ABIMIG® A T			72	
	FOR ABIMIG® W & ABIMIG® W T			78	
	FOR MB			82	
	BIKOX® CABLES ■ CONTROL CABLES ■ HOSES			88	
	HANDLES ■ MODULES			90	

GAS COOLED



LIQUID COOLED





MB EVO PRO

MIG/MAG WELDING TORCHES **MB EVO PRO**



- ✓ **Gas or liquid cooling**
- ✓ **Lightweight BIKOX® LW cable assembly**
- ✓ **Optimal handling concept**

Experienced professionals: The torch series MB EVO PRO is the established standard for demanding industrial welding. The torches are optionally available in gas or liquid cooled versions. Gas cooled MB EVO PRO torches with the particularly light BIKOX® LW cable assembly enable relaxed welding in any position. Due to the cooler frontend, liquid cooled MB EVO PRO torches offer especially long service lives and additional power reserves. All MB EVO PRO torches are excellent to handle and fit perfectly in the hand.

MB EVO PRO advantages

- Maximum service life and proven MB wear part concept
- Lightweight BIKOX® LW cable assembly takes the strain off the welder
- Robust, ergonomic 2-component handle
- Easy-to-repair design, simplest maintenance
- Remote control modules optionally available



OPTIMAL
BALANCE



PERFECT
ERGONOMICS

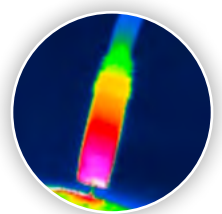

OPTIMIZED
COOLING

For special torch necks & gas nozzles see chapter "Accessories & special equipment"



Type	Cooling	CO ₂	Mixed gas M21*	Duty cycle	Wire Ø
MB EVO PRO 15	gas cooled	180 A	150 A	60%	0.6 - 1.0 mm
MB EVO PRO 25	gas cooled	230 A	200 A	60%	0.8 - 1.2 mm
MB EVO PRO 24	gas cooled	250 A	220 A	60%	0.8 - 1.2 mm
MB EVO PRO 26	gas cooled	270 A	240 A	60%	0.8 - 1.2 mm
MB EVO PRO 36	gas cooled	320 A	290 A	60%	0.8 - 1.2 mm
MB EVO PRO 240 D	liquid cooled	325 A	300 A	100%	0.8 - 1.2 mm
MB EVO PRO 401 D	liquid cooled	450 A	500 A	100%	0.8 - 1.2 mm
MB EVO PRO 501 D	liquid cooled	550 A	500 A	100%	1.0 - 1.6 mm

Technical data according to EN 60 974-7 ▪ DIN EN ISO 14175

MIG/MAG WELDING TORCHES **MB EVO PRO**

MB EVO PRO 15 / 15 FLEX ■ **MB EVO PRO 25 / 25 FLEX**



All documents in one place: ABIDOC



MB EVO PRO 15

MB EVO PRO 25

Also available with flexible torch neck!

150 – 230 A



MB EVO PRO 15 / 15 FLEX

Rating: 180 A CO₂
150 A Mixed gas M21*
Duty cycle: 60%
Wire Ø: 0.6–1.0 mm



MB EVO PRO 25 / 25 FLEX

Rating: 230 A CO₂
200 A Mixed gas M21*
Duty cycle: 60%
Wire Ø: 0.8–1.2 mm

Torch complete		Part-No.			Torch neck	
Type	Cooling	3 m	4 m	5 m	Type	Part-No.
MB EVO PRO 15	gas cooled	002.0712.1	002.0713.1	002.0714.1	50°	002.0715.1
MB EVO PRO 15 FLEX	gas cooled	002.0779.1	002.0780.1	002.0781.1	FLEX	002.0029**
MB EVO PRO 25	gas cooled	004.0671.1	004.0672.1	004.0673.1	50°	004.0663.1
MB EVO PRO 25 FLEX	gas cooled	004.0805.1	004.0806.1	004.0807.1	FLEX	004.0032**

Technical data according to EN 60 974-7 ■ *DIN EN ISO 14175

Wear parts

MB EVO PRO 15

MB EVO PRO 25

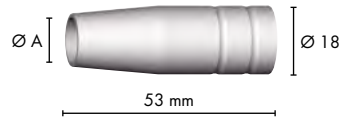

Gas nozzle (10 pcs.)	Ø A		Ø B	
Cylindrical	Ø 16	145.0041	Ø 18	145.0042
Conical	Ø 12	145.0075*	Ø 15	145.0076**
Tapered	Ø 9.5	145.0123	Ø 11.5	145.0124

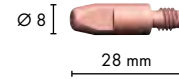
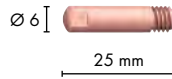

Contact tip (10 pcs.)		M6	M6
E-Cu	Ø 0.6	140.0008	-
	Ø 0.8	140.0059	140.0051
	Ø 1.0	140.0253	140.0242
	Ø 1.2	-	140.0379
CuCrZr	Ø 0.6	140.0855	-
	Ø 0.8	140.0062*	140.0054
	Ø 1.0	140.0256	140.0245**
	Ø 1.2	-	140.0382

For more contact tips see chapter "Accessories & special equipment"



Nozzle spring (100 pcs.)		
	002.0058*	003.0013**

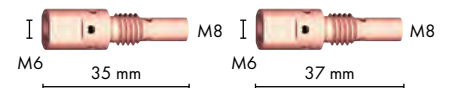

Gas nozzle holder (1 pc.) Contact tip holder (10 pcs.)			
M6	002.0078.10*	142.0001**	142.0267.10
		142.0015	



Liner	Ø	for 3 m	for 4 m	for 5 m
Insulated liner	Ø 0.6	124.0011	124.0012	124.0015
	Ø 0.8	124.0011*	124.0012*	124.0015*
	Ø 1.0	124.0026**	124.0031**	124.0035**
	Ø 1.2	124.0026	124.0031	124.0035

For more liner see chapter "Accessories & special equipment"

Standard equipment

* Included in the standard equipment for complete torches MB EVO PRO 15

** Included in the standard equipment for complete torches MB EVO PRO 25

MIG/MAG WELDING TORCHES **MB EVO PRO**

MB EVO PRO 24 ■ **MB EVO PRO 26** ■ **MB EVO PRO 36**



All documents in one place: ABIDOC



MB EVO PRO 24

MB EVO PRO 26

MB EVO PRO 36



MB EVO PRO 24

Rating: 250 A CO₂
220 A Mixed gas M21*
Duty cycle: 60%
Wire Ø: 0.8-1.2 mm



MB EVO PRO 26

Rating: 270 A CO₂
240 A Mixed gas M21*
Duty cycle: 60%
Wire Ø: 0.8-1.2 mm



MB EVO PRO 36

Rating: 320 A CO₂
290 A Mixed gas M21*
Duty cycle: 60%
Wire Ø: 0.8-1.2 mm

220 –
320 A

Optional control modules can be found on page 90.

Torch complete		Part-No.			Torch neck	
Type	Cooling	3 m	4 m	5 m	Type	Part-No.
MB EVO PRO 24	gas cooled	012.0371.1	012.0372.1	012.0373.1	50°	012.0374.1
MB EVO PRO 26	gas cooled	018.0211.1	018.0212.1	018.0213.1	50°	018.0214.1
MB EVO PRO 36	gas cooled	014.0529.1	014.0530.1	014.0531.1	50°	014.0518.1

Technical data according to EN 60 974-7 ■ *DIN EN ISO 14175

Wear parts

MB EVO PRO 24

MB EVO PRO 26

MB EVO PRO 36

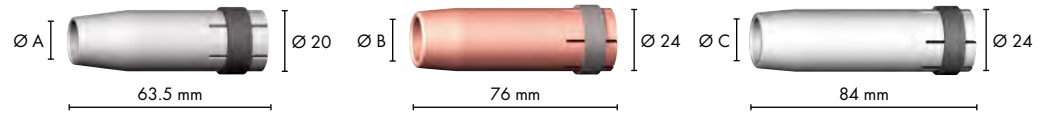

Gas nozzle (10 pcs.)	Ø A		Ø B		Ø C	
Cylindrical	Ø 17	145.0047	Ø 20	145.0051	Ø 19	145.0045
Conical	Ø 12.5	145.0080*	Ø 16	145.0085**	Ø 16	145.0078***
Tapered	Ø 10	145.0128	Ø 14	145.0132	Ø 12	145.0126

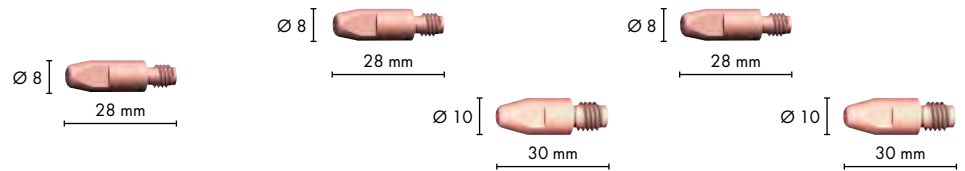

Contact tip (10 pcs.)		M6	M6	M8	M6	M8
E-Cu	Ø 0.8	140.0051	140.0051	140.0114	140.0051	140.0114
	Ø 1.0	140.0242	140.0242	140.0313	140.0242	140.0313
	Ø 1.2	140.0379	140.0379	140.0442	140.0379	140.0442
CuCrZr	Ø 0.8	140.0054	140.0054	140.0117	140.0054	140.0117
	Ø 1.0	140.0245*	140.0245**	140.0316	140.0245	140.0316
	Ø 1.2	140.0382	140.0382	140.0445	140.0382	140.0445***

For more contact tips see chapter "Accessories & special equipment"

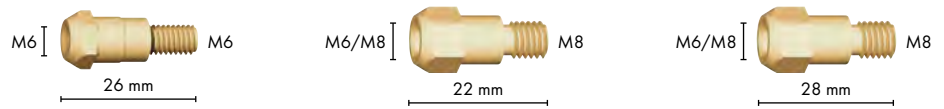

Contact tip holder (10 pcs.)			
M6	142.0003*	142.0007**	142.0005
M8	-	142.0082	142.0020***



Gas diffuser (10 pcs.)			
Standard	012.0432.10*	018.0260.10**	014.0748.10***
Long life	-	-	014.0026
Ceramic	-	018.0141	014.0023



Liner	Ø	for 3 m	for 4 m	for 5 m
Insulated liner	Ø 0.8	124.0011	124.0012	124.0015
	Ø 1.0	124.0026**	124.0031**	124.0035**
	Ø 1.2	124.0026***	124.0031***	124.0035***

For more liner see chapter "Accessories & special equipment"

Standard equipment

* Included in the standard equipment for complete torches MB EVO PRO 24

** Included in the standard equipment for complete torches MB EVO PRO 26

*** Included in the standard equipment for complete torches MB EVO PRO 36

MIG/MAG WELDING TORCHES **MB EVO PRO**

MB EVO PRO 240 D ■ **MB EVO PRO 401 D**

MB EVO PRO 501 D



All documents in
one place: ABIDOC

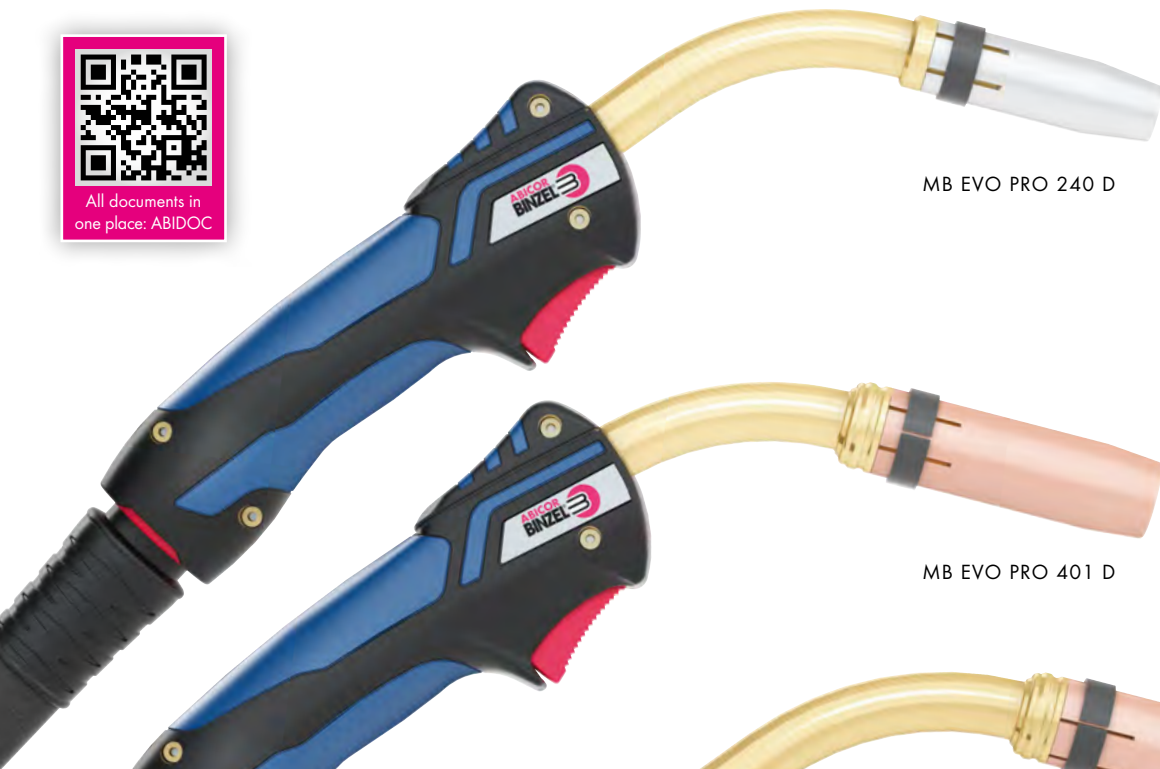

MB EVO PRO 240 D



MB EVO PRO 401 D



MB EVO PRO 501 D



Optional control modules
can be found on page 90.

**300 –
550 A**

Note for liquid cooled torches:

To protect cable assembly components from excessive heat build up we recommend a post welding cooling cycle of at least 4 minutes.



MB EVO PRO 240 D

Rating: 325 A CO₂
300 A Mixed gas M21*
Duty cycle: 100 %
Wire Ø: 0.8–1.2 mm



MB EVO PRO 401 D

Rating: 450 A CO₂
400 A Mixed gas M21*
Duty cycle: 100 %
Wire Ø: 0.8–1.2 mm



MB EVO PRO 501 D

Rating: 550 A CO₂
500 A Mixed gas M21*
Duty cycle: 100 %
Wire Ø: 1.0–1.6 mm

Torch complete		Part-No.			Torch neck	
Type	Cooling	3 m	4 m	5 m	Type	Part-No.
MB EVO PRO 240 D	liquid cooled	023.0319.1	023.0320.1	023.0321.1	50°	023.0316.1
MB EVO PRO 401 D	liquid cooled	033.0384.1	033.0385.1	033.0386.1	50°	033.0378.1
MB EVO PRO 501 D	liquid cooled	034.0862.1	034.0863.1	034.0864.1	50°	034.0856.1

Technical data according to EN 60 974-7 ■ *DIN EN ISO 14175

Wear parts

MB EVO PRO 240 D

MB EVO PRO 401/501 D

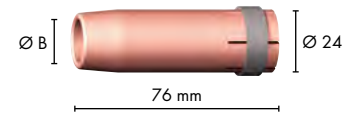
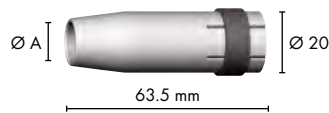

Gas nozzle (10 pcs.)	Ø A		Ø B	
Cylindrical	Ø 17	145.0047	Ø 20	145.0051
Conical	Ø 12.5	145.0080*	Ø 16	145.0085**
Tapered	Ø 10	145.0128	Ø 14	145.0132
Conical	-	-	Ø 10	145.0137

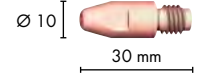
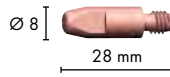

Contact tip (10 pcs.)		M6	M6	M8
E-Cu	Ø 0.8	140.0051	140.0051	140.0114
	Ø 1.0	140.0242	140.0242	140.0313
	Ø 1.2	140.0379	140.0379	140.0442
	Ø 1.6	-	140.0555	140.0587
CuCrZr	Ø 0.8	140.0054	140.0054	140.0117
	Ø 1.0	140.0245*	140.0245	140.0316
	Ø 1.2	140.0382	140.0382	140.0445**
	Ø 1.6	-	140.0558	140.0590

For more contact tips see chapter "Accessories & special equipment"

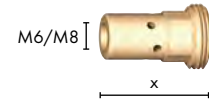
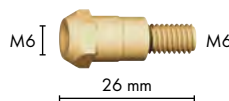

Contact tip holder (10 pcs.)			x	recess
M6 (Ms)	142.0003*	142.0008	25 mm	-4.5 mm
M8 (Ms)	-	142.0022	25 mm	-4.5 mm
M8 (CuCrZr)	-	142.0201.10	27 mm	-2.5 mm
M8 (Ms)	-	142.0027	29 mm	flush



Gas diffuser (10 pcs.)		
Standard	012.0432.10*	030.0265.10**
Long life	-	030.0255.10
Ceramic	-	030.0190



Liner	Ø	for 3 m	for 4 m	for 5 m
Insulated liner	Ø 0.8	124.0137	124.0138	124.0139
	Ø 1.0	124.0111*	124.0112*	124.0113*
	Ø 1.2	124.0111**	124.0112**	124.0113**
	Ø 1.6	124.0114	124.0115	124.0116

For more liner see chapter "Accessories & special equipment"

Standard equipment

* Included in the standard equipment for complete torches MB EVO PRO 240

** Included in the standard equipment for complete torches MB EVO PRO 401 D/501 D



MB EVO

MIG/MAG WELDING TORCHES **MB EVO**

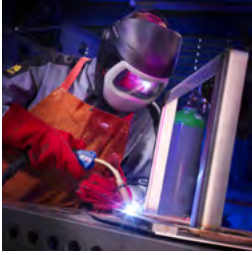

- ✓ **Proven, robust industrial torches**
- ✓ **With gas or liquid cooling**
- ✓ **Versatile use**

Robust classics: With their tried and tested torch technology and proven design, torches of the MB EVO series are the ideal solution for everyone looking for a robust, reliable torch with a very good price-performance ratio. Thanks to their ergonomic design, they form a perfect unit with the welder's hand. Thus, they permanently ensure the best welding results even under rough operating conditions.

MB EVO advantages

- Maximum service life and proven MB wear part concept
- Easy-to-repair design, simplest maintenance
- Robust 2-component handle
- Ergonomic design for best handling in any position



For special gas nozzles see chapter
"Accessories & special equipment"



Type	Cooling	CO ₂	Mixed gas M21*	Duty cycle	Wire Ø
MB EVO 15	gas cooled	180/150 A	180/150 A	35%/60%	0.6-1.0 mm
MB EVO 25	gas cooled	230 A	200 A	60%	0.8-1.2 mm
MB EVO 24	gas cooled	250 A	220 A	60%	0.8-1.2 mm
MB EVO 36	gas cooled	320 A	290 A	60%	0.8-1.2 mm
MB EVO 240 D	liquid cooled	300 A	270 A	100%	0.8-1.2 mm
MB EVO 401 D	liquid cooled	400 A	350 A	100%	0.8-1.2 mm
MB EVO 501 D	liquid cooled	500 A	450 A	100%	1.0-1.6 mm

Technical data according to EN 60 974-7 ▪ *DIN EN ISO 14175

MIG/MAG WELDING TORCHES **MB EVO**

MB EVO 15 ■ **MB EVO 25**



All documents in one place: ABIDOC



MB EVO 15

MB EVO 25

**150 –
230 A**



MB EVO 15

Rating: 180/150 A CO₂
180/150 A Mixed gas M21*
Duty cycle: 35%/60%
Wire Ø: 0.6–1.0 mm



MB EVO 25

Rating: 230 A CO₂
200 A Mixed gas M21*
Duty cycle: 60%
Wire Ø: 0.8–1.2 mm

Torch complete		Part-No.			Torch neck	
Type	Cooling	3 m	4 m	5 m	Type	Part-No.
MB EVO 15	gas cooled	002.0709.1	002.0710.1	002.0711.1	50°	002.0715.1
MB EVO 25	gas cooled	004.0668.1	004.0669.1	004.0670.1	50°	004.0663.1

Technical data according to EN 60 974-7 ■ *DIN EN ISO 14175

Wear parts

MB EVO 15

MB EVO 25



Gas nozzle (10 pcs.)	Ø A		Ø B	
Cylindrical	Ø 16	145.0041	Ø 18	145.0042
Conical	Ø 12	145.0075*	Ø 15	145.0076**
Tapered	Ø 9.5	145.0123	Ø 11.5	145.0124

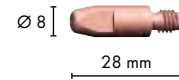
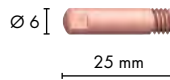

Contact tip (10 pcs.)	M6		M6	
E-Cu	Ø 0.6	140.0008	-	-
	Ø 0.8	140.0059*	140.0051	-
	Ø 1.0	140.0253	140.0242**	-
	Ø 1.2	-	140.0379	-
CuCrZr	Ø 0.6	140.0855	-	-
	Ø 0.8	140.0062	140.0054	-
	Ø 1.0	140.0256	140.0245	-
	Ø 1.2	-	140.0382	-

For more contact tips see chapter "Accessories & special equipment"



Nozzle spring (100 pcs.)	002.0058*	003.0013**
--------------------------	-----------	------------

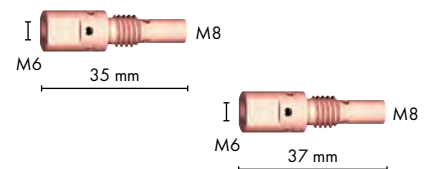
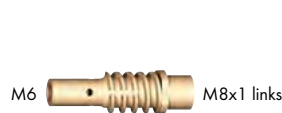

Gas nozzle holder (1 pc.) Contact tip holder (10 pcs.)	002.0078.10*	142.0001**	142.0267.10
---	--------------	------------	-------------



Liner	Ø	for 3 m	for 4 m	for 5 m
Insulated liner	Ø 0.6	124.0011	124.0012	124.0015
	Ø 0.8	124.0011*	124.0012*	124.0015*
	Ø 1.0	124.0026**	124.0031**	124.0035**
	Ø 1.2	124.0026	124.0031	124.0035

For more liner see chapter "Accessories & special equipment"

Standard equipment

* Included in the standard equipment for complete torches MB EVO 15

** Included in the standard equipment for complete torches MB EVO 25

MIG/MAG WELDING TORCHES **MB EVO**

MB EVO 24 ■ **MB EVO 36**



All documents in one place: ABIDOC



MB EVO 24

MB EVO 36



MB EVO 24

Rating: 250 A CO₂
220 A Mixed gas M21*
Duty cycle: 60%
Wire Ø: 0.8–1.2 mm



MB EVO 36

Rating: 320 A CO₂
290 A Mixed gas M21*
Duty cycle: 60%
Wire Ø: 0.8–1.2 mm

**220 –
320 A**

Torch complete		Part-No.			Torch neck	
Type	Cooling	3 m	4 m	5 m	Type	Part-No.
MB EVO 24	gas cooled	012.0368.1	012.0369.1	012.0370.1	50°	012.0374.1
MB EVO 36	gas cooled	014.0526.1	014.0527.1	014.0528.1	50°	014.0518.1

Technical data according to EN 60 974-7 ■ *DIN EN ISO 14175

Wear parts

MB EVO 24

MB EVO 36

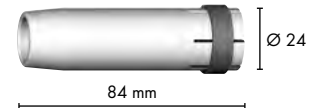

Gas nozzle (10 pcs.)	Ø A		Ø C	
Cylindrical	Ø 17	145.0047	Ø 19	145.0045
Conical	Ø 12.5	145.0080*	Ø 16	145.0078**
Tapered	Ø 10	145.0128	Ø 12	145.0126

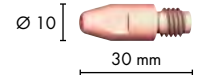
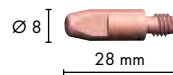

Contact tip (10 pcs.)		M6	M6	M8
E-Cu	Ø 0.8	140.0051	140.0051	140.0114
	Ø 1.0	140.0242*	140.0242	140.0313
	Ø 1.2	140.0379	140.0379	140.0442**
CuCrZr	Ø 0.8	140.0054	140.0054	140.0117
	Ø 1.0	140.0245	140.0245	140.0316
	Ø 1.2	140.0382	140.0382	140.0445

For more contact tips see chapter "Accessories & special equipment"

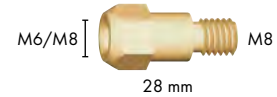
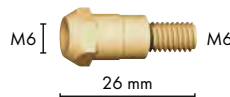

Contact tip holder (10 pcs.)		
M6	142.0003*	142.0005
M8	-	142.0020**



Gas diffusor (10 pcs.)		
Standard	012.0432.10*	014.0748.10**
Long life	-	014.0026
Ceramic	-	014.0023



Liner	Ø	for 3 m	for 4 m	for 5 m
Insulated liner isoliert	Ø 0.8	124.0011	124.0012	124.0015
	Ø 1.0	124.0026*	124.0031*	124.0035*
	Ø 1.2	124.0026**	124.0031**	124.0035**

For more liner see chapter "Accessories & special equipment"

Standard equipment

* Included in the standard equipment for complete torches MB EVO 24

** Included in the standard equipment for complete torches MB EVO 36

MIG/MAG WELDING TORCHES **MB EVO**

MB EVO 240 D ■ MB EVO 401 D ■ MB EVO 501 D



All documents in one place: ABIDOC

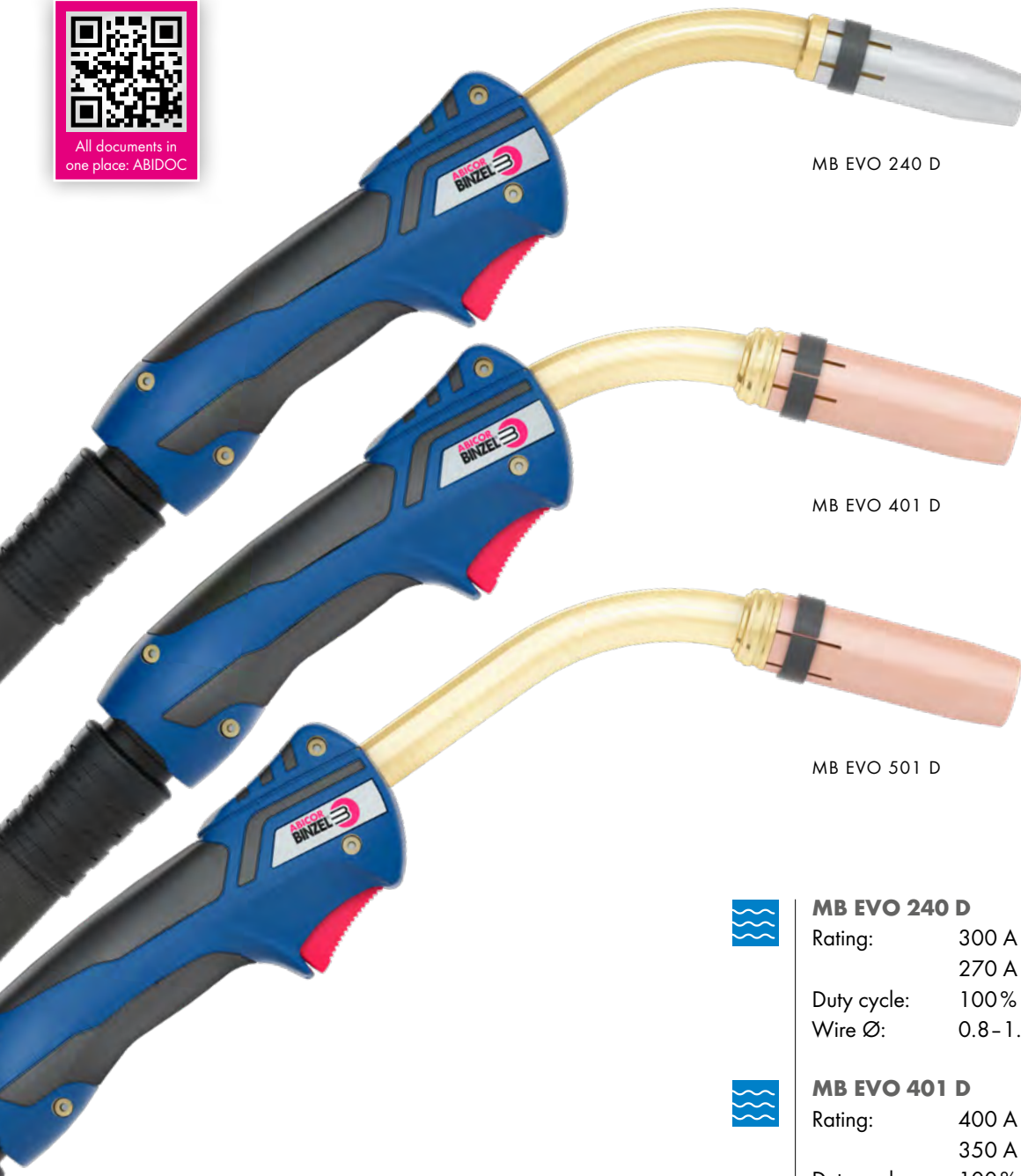

MB EVO 240 D

MB EVO 401 D

MB EVO 501 D



MB EVO 240 D

Rating: 300 A CO₂
270 A Mixed gas M21*
Duty cycle: 100%
Wire Ø: 0.8-1.2 mm



MB EVO 401 D

Rating: 400 A CO₂
350 A Mixed gas M21*
Duty cycle: 100%
Wire Ø: 0.8-1.2 mm



MB EVO 501 D

Rating: 500 A CO₂
450 A Mixed gas M21*
Duty cycle: 100%
Wire Ø: 1.0-1.6 mm

270 – 500 A

Note for liquid cooled torches:

To protect cable assembly components from excessive heat build up we recommend a post welding cooling cycle of at least 4 minutes.

Torch complete		Part-No.			Torch neck	
Type	Cooling	3 m	4 m	5 m	Type	Part-No.
MB EVO 240 D	liquid cooled	023.0322.1	023.0323.1	023.0324.1	50°	023.0316.1
MB EVO 401 D	liquid cooled	033.0387.1	033.0388.1	033.0389.1	50°	033.0378.1
MB EVO 501 D	liquid cooled	034.0865.1	034.0866.1	034.0867.1	50°	034.0856.1

Technical data according to EN 60 974-7 ■ *DIN EN ISO 14175

Wear parts

MB EVO 240 D

MB EVO 401 D/501 D

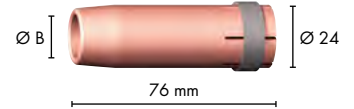

Gas nozzle (10 pcs.)	Ø A		Ø B	
Cylindrical	Ø 17	145.0047	Ø 20	145.0051
Conical	Ø 12.5	145.0080*	Ø 16	145.0085**
Tapered	Ø 10	145.0128	Ø 14	145.0132

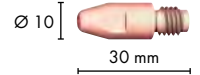
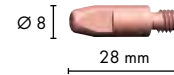
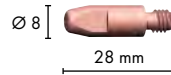

Contact tip (10 pcs.)		M6	M6	M8
E-Cu	Ø 0.8	140.0051	140.0051	140.0114
	Ø 1.0	140.0242*	140.0242	140.0313
	Ø 1.2	140.0379	140.0379	140.0442**
	Ø 1.6	-	140.0555	140.0587
CuCrZr	Ø 0.8	140.0054	140.0054	140.0117
	Ø 1.0	140.0245	140.0245	140.0316
	Ø 1.2	140.0382	140.0382	140.0445
	Ø 1.6	-	140.0558	140.0590

For more contact tips see chapter "Accessories & special equipment"

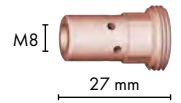
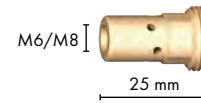
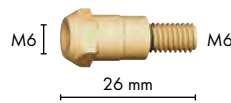

Contact tip holder (10 pcs.)			
M6	142.0003*	142.0008	-
M8	-	142.0022**	142.0201.10



Gas diffuser (10 pcs.)		
Standard	012.0432.10*	030.0265.10**
Long life	-	030.0255.10
Ceramic	-	030.0190



Liner	Ø	for 3 m	for 4 m	for 5 m
Insulated liner	Ø 0.8	124.0137	124.0138	124.0139
	Ø 1.0	124.0111*	124.0112*	124.0113*
	Ø 1.2	124.0111**	124.0112**	124.0113**
	Ø 1.6	124.0114	124.0115	124.0116

For more liner see chapter "Accessories & special equipment"

Standard equipment

* Included in the standard equipment for complete torches MB EVO 240 D

** Included in the standard equipment for complete torches MB EVO 401 D /501 D



Speedglas

STERSOIN
CE
EN 470-1
WELDAS
STERSOIN 44-7142
SIZE 10cm LENGTH

ABIMIG® GRIP

MIG/MAG WELDING TORCHES **ABIMIG® GRIP**



- ✓ **Liquid cooling with dual-circuit cooling system**
- ✓ **For high power and impulse welding**
- ✓ **Durable MB wear parts**

Cool power packs: Torches of the liquid cooled ABIMIG® GRIP series show their strengths in the high power range and impulse welding. Their dual-circuit cooling system cools the torches reliably at all times, even when welding long seams at high power. This protects the torches and ensures particularly long service lives as well as reduced replacement costs. Thanks to standard wear parts of the MB series, the variety of parts and storage costs are reduced. ABIMIG® GRIP torches are optionally available with screw-on gas nozzle and various remote control modules.

ABIMIG® GRIP advantages

- Particularly long service lives due to the dual-circuit cooling system
- Economical stock-keeping due to MB wear parts
- Optimal balance thanks to handle with ball joint
- Comfortable operation due to remote control modules on the handle (optional)
- Screw-on gas nozzle TS (optional)



For special gas nozzles see chapter
"Accessories & special equipment"



Type	Cooling	CO ₂	Mixed gas M21*	Duty cycle	Wire Ø
ABIMIG® GRIP W 555 D	liquid cooled	550 A	500/400**A	100%	0.8-1.6 mm
ABIMIG® GRIP W 555 D TS	liquid cooled	550 A	500/400**A	100%	0.8-1.6 mm

Technical data according to EN 60 974-7 ■ DIN EN ISO 14175 ■ **Pulse

MIG/MAG WELDING TORCHES **ABIMIG® GRIP W**

ABIMIG® GRIP W 555 D ■ **ABIMIG® GRIP W 555 D TS**



All documents in one place: ABIDOC



ABIMIG® GRIP W 555 D

ABIMIG® GRIP W 555 D TS

400 – 550 A

Note for liquid cooled torches:

To protect cable assembly components from excessive heat build up we recommend a post welding cooling cycle of at least 4 minutes.



ABIMIG® GRIP W 555 D **ABIMIG® GRIP W 555 D TS**

Rating: 550 A CO₂
500 A Mixed gas M21*
400 A Pulse
Duty cycle: 100%
Wire Ø: 0.8–1.6 mm

Torch complete		Part-No.			Torch neck	
Type	Cooling	3 m	4 m	5 m	Type	Part-No.
ABIMIG® GRIP W 555 D	liquid cooled	766.0526.1	766.0527.1	766.0528.1	50°	766.0532.1
ABIMIG® GRIP W 555 D TS	liquid cooled	766.1457.1	766.1458.1	766.1459.1	50°	766.0900.1

Technical data according to EN 60 974-7 ■ *DIN EN ISO 14175

Wear parts

ABIMIG® GRIP W 555 D

ABIMIG® GRIP W 555 D TS

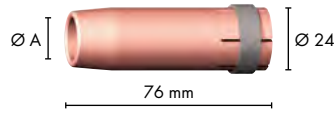

Gas nozzle	Ø A (plugged; 10 pcs.)		Ø B (screwed; 5 pcs.)	
Cylindrical	Ø 20	145.0051	Ø 20	145.0709.5
Conical	Ø 16	145.0085*	Ø 16	145.0708.5**
Tapered	Ø 14	145.0132	Ø 13	145.0734.5

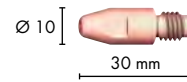
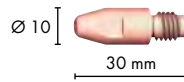

Contact tip (10 pcs.)	M8		M8	
E-Cu	Ø 0.8	140.0114	140.0114	
	Ø 1.0	140.0313	140.0313	
	Ø 1.2	140.0442	140.0442	
	Ø 1.6	140.0587	140.0587	
CuCrZr	Ø 0.8	140.0117	140.0117	
	Ø 1.0	140.0316	140.0316	
	Ø 1.2	140.0445*	140.0445**	
	Ø 1.6	140.0590	140.0590	

For more contact tips see chapter "Accessories & special equipment"

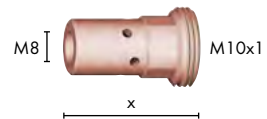
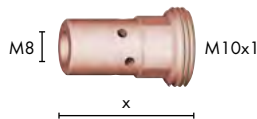

Contact tip holder (10 pcs.)		x	recess		x	recess
M8 (CuCrZr)	142.0201.10**	27 mm	-2.5 mm	142.0201.10**	27 mm	-2.5 mm
M8 (Ms)	142.0022	25 mm	-4.5 mm	142.0022	25 mm	-4.5 mm
M8 (Ms)	142.0027	29 mm	flush	142.0027	29 mm	flush



Gas diffuser (10 pcs.)		
Standard	030.0265.10*	030.0265.10**
Long life	030.0255.10	030.0255.10
Ceramic	030.0190	030.0190



Liner	Ø	for 3 m	for 4 m	for 5 m
Insulated liner	Ø 0.8	124.0137	124.0138	124.0139
	Ø 1.0	124.0111	124.0112	124.0113
	Ø 1.2	124.0111**	124.0112**	124.0113**
	Ø 1.6	124.0114	124.0115	124.0116

For more liner see chapter "Accessories & special equipment"

Standard equipment

* Included in the standard equipment for complete torches ABIMIG® GRIP W 555 D

** Included in the standard equipment for complete torches ABIMIG® GRIP W 555 D TS



ABIMIG® AT LW

MIG/MAG WELDING TORCHES **ABIMIG® A T LW**



- **Rotatable and exchangeable torch necks**
- **Lightweight BIKOX® LW cable assembly**
- **Handles in two sizes**

Flexible all-rounders: Changing welding positions and different welding tasks are the speciality of the ABIMIG® A T LW torches. The torches have an unbeatable power-to-weight ratio. With 360-degree rotatable and exchangeable torch necks and a super lightweight BIKOX® LW cable, they enable ergonomic working in every position. And thanks to numerous additional components, ABIMIG® A T LW torches can be easily adapted to different welding tasks.

ABIMIG® A T LW advantages

- Handles available in two sizes (standard and small)
- Quick-change torch neck, reduced service costs
- Universal contact tip holder instead of gas diffusor for reduced wear part costs
- Longer service life thanks to screw-on, thermally insulated gas nozzle

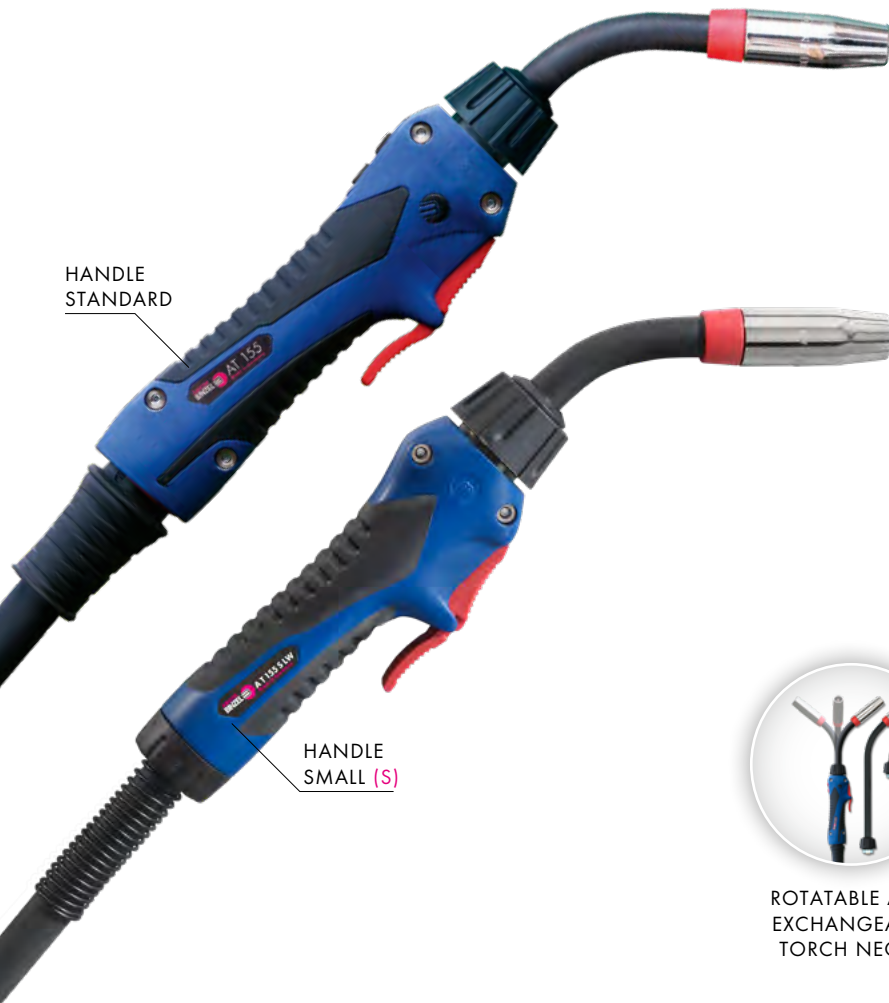

ROTATABLE AND EXCHANGEABLE TORCH NECKS



LIGHTWEIGHT BIKOX® LW CABLE



EXTENDABLE TRIGGER

For special gas nozzles see chapter "Accessories & special equipment"



Type	Cooling	CO ₂	Mixed gas M21*	Duty cycle	Wire Ø
ABIMIG® A T 155 LW	gas cooled	190 A	180 A	60%	0.8 - 1.0 mm
ABIMIG® A T 255 LW	gas cooled	240 A	220 A	60%	0.8 - 1.2 mm
ABIMIG® A T 305 LW	gas cooled	290 A	260 A	60%	0.8 - 1.2 mm
ABIMIG® A T 355 LW	gas cooled	340 A	320 A	60%	1.0 - 1.6 mm
ABIMIG® A T 405 LW	gas cooled	400 A	370 A	60%	1.0 - 1.6 mm
ABIMIG® A T 155 S LW	gas cooled	160 A	160 A	60%	0.8 - 1.0 mm
ABIMIG® A T 255 S LW	gas cooled	210 A	210 A	60%	0.8 - 1.2 mm
ABIMIG® A T 355 S LW	gas cooled	320 A	300 A	60%	1.0 - 1.6 mm

Technical data according to EN 60 974-7 ▪ DIN EN ISO 14175

MIG/MAG WELDING TORCHES **ABIMIG® A T LW**

ABIMIG® A T 155 LW ■ **ABIMIG® A T 255 LW**



All documents in one place: ABIDOC



ABIMIG® A T 155 LW

ABIMIG® A T 255 LW

Lightweight torches with rotatable and exchangeable torch necks

180 – 240 A

Definition:

T = turnable/exchangeable torch neck
LW = lightweight cable assembly



ABIMIG® A T 155 LW

Rating: 190 A CO₂
180 A Mixed gas M21*
Duty cycle: 60%
Wire Ø: 0.8–1.0 mm



ABIMIG® A T 255 LW

Rating: 240 A CO₂
220 A Mixed gas M21*
Duty cycle: 60%
Wire Ø: 0.8–1.2 mm

Torch Type	Cooling	Part-No.			Torch neck	
		3 m	4 m	5 m	Type	Part-No.
ABIMIG® A T 155 LW	gas cooled	006.D810.1	006.D811.1	006.D812.1	45°	006.D804.1
ABIMIG® A T 255 LW	gas cooled	004.D850.1	004.D851.1	004.D852.1	45°	004.D831.1
Base torch ABIMIG® A T G 155 LW**	gas cooled	006.D841.1	006.D842.1	006.D843.1	from page 72	
Base torch ABIMIG® A T G 255 LW**	gas cooled	004.D894.1	004.D895.1	004.D896.1	from page 72	

Technical data according to EN 60 974-7 ■ *DIN EN ISO 14175 ■ ** A T G = Base torch without torch neck

Wear parts

ABIMIG® A T 155 LW

ABIMIG® A T 255 LW

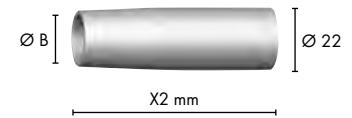
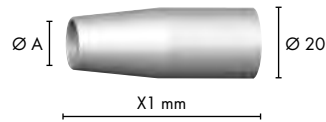

Gas nozzle (5 pcs.)	Ø A	X1		Ø B	X2	
Cylindrical	Ø 17	52 mm	145.D003.5	Ø 18	69 mm	145.D014.5
Conical	Ø 12	52 mm	145.D001.5*	Ø 16	70 mm	145.D011.5**
Tapered	Ø 10	52 mm	145.D006.5	Ø 14	67 mm	145.D012.5

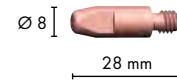
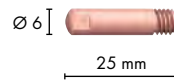

Contact tip (10 pcs.)		M6	M6
E-Cu	Ø 0.8	140.0059*	140.0051
	Ø 1.0	140.0253	140.0242**
	Ø 1.2	-	140.0379
CuCrZr	Ø 0.8	140.0062	140.0054
	Ø 1.0	140.0256	140.0245
	Ø 1.2	-	140.0382

For more contact tips see chapter "Accessories & special equipment"

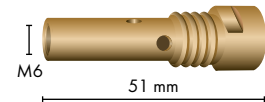
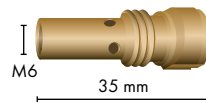

Contact tip holder (5 pcs.)		
M6	006.D719.5*	004.D624.5**



Adapter piece (5 pcs.)		
	767.D607.5*	767.D637.5**



Torch neck liner for T-torches			
Standard	Ø 0.8	122.D037* (5 pcs.)	122.D037 (5 pcs.)
	Ø 1.0	122.D038 (5 pcs.)	122.D038** (5 pcs.)
	Ø 1.2	-	122.D038 (5 pcs.)
Brass for Al	Ø 0.8	122.D040	122.D040
	Ø 1.0	122.D040	122.D041
	Ø 1.2	-	122.D041



Liner	Ø	for 3 m	for 4 m	for 5 m
Insulated liner	Ø 0.8	124.0011*	124.0012*	124.0015*
	Ø 1.0	124.0026**	124.0031**	124.0035**
	Ø 1.2	124.0026	124.0031	124.0035

For more liner see chapter "Accessories & special equipment"

Standard equipment

* Included in the standard equipment for complete torches ABIMIG® A T 155 LW

** Included in the standard equipment for complete torches ABIMIG® A T 255 LW

MIG/MAG WELDING TORCHES **ABIMIG® A T LW**

ABIMIG® A T 305 LW ■ **ABIMIG® A T 355 LW**

ABIMIG® A T 405 LW



All documents in one place: ABIDOC



ABIMIG® A T 305 LW

ABIMIG® A T 355 LW

ABIMIG® A T 405 LW

Lightweight torches with rotatable and exchangeable torch necks

260 – 400 A

Definition:

T = turnable/exchangeable torch neck
LW = lightweight cable assembly



ABIMIG® A T 305 LW

Rating: 290 A CO₂
260 A Mixed gas M21*
Duty cycle: 60%
Wire Ø: 0.8–1.2 mm



ABIMIG® A T 355 LW

Rating: 340 A CO₂
320 A Mixed gas M21*
Duty cycle: 60%
Wire Ø: 1.0–1.6 mm



ABIMIG® A T 405 LW

Rating: 400 A CO₂
370 A Mixed gas M21*
Duty cycle: 60%
Wire Ø: 1.0–1.6 mm (up to 2.4 mm on request)

Torch Type	Cooling	Part-No.			Torch neck	
		3 m	4 m	5 m	Type	Part-No.
ABIMIG® A T 305 LW	gas cooled	018.D960.1	018.D961.1	018.D962.1	45°	014.H356.1
ABIMIG® A T 355 LW	gas cooled	014.H390.1	014.H391.1	014.H392.1	45°	014.H363.1
ABIMIG® A T 405 LW	gas cooled	015.D070.1	015.D071.1	015.D072.1	45°	015.D082.1
Base torch ABIMIG® A T G 355 LW**	gas cooled	014.H544.1	014.H545.1	014.H546.1	from page 72	
Base torch ABIMIG® A T G 405 LW**	gas cooled	015.D114.1	015.D115.1	015.D116.1	from page 72	

Technical data according to EN 60 974-7 ■ *DIN EN ISO 14175 ■ ** A T G = Base torch without torch neck

Wear parts

ABIMIG® A T 305 / 355 LW

ABIMIG® A T 405 LW

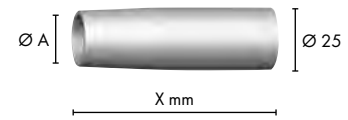
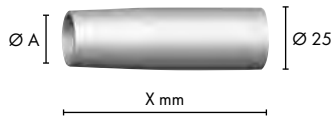

Gas nozzle (5 pcs.)	Ø A	X		Ø A	X	
Cylindrical	Ø 21	71 mm	145.D024.5	Ø 21	71 mm	145.D024.5
Conical	Ø 18	72 mm	145.D021.5**	Ø 18	72 mm	145.D021.5***
Tapered	Ø 16	69 mm	145.D022.5	Ø 16	69 mm	145.D022.5

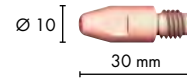
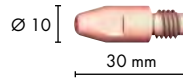

Contact tip (10 pcs.)		M8	M8
E-Cu	Ø 0.8	140.0114	140.0114
	Ø 1.0	140.0313	140.0313
	Ø 1.2	140.0442	140.0442
	Ø 1.6	140.0587	140.0587
CuCrZr	Ø 0.8	140.0117	-
	Ø 1.0	140.0316	140.0316
	Ø 1.2	140.0445**	140.0445
	Ø 1.6	140.0590	140.0590***

For more contact tips see chapter "Accessories & special equipment"

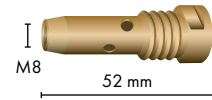
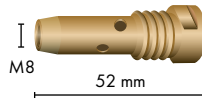

Contact tip holder (5 pcs.)		
M8	014.D745.5**	014.D745.5***



Adapter piece (5 pcs.)		
	767.D668.5**	015.D080.5***



Torch neck liner for T-torches			
Standard	Ø 0.8	122.D037 (5 pcs.)	-
	Ø 1.0-1.2	122.D038** (5 pcs.)	122.D077 (5 pcs.)
	Ø 1.6	122.D045 (5 pcs.)	122.D078*** (5 pcs.)
Brass for Al	Ø 1.0	122.D040	122.D040
	Ø 1.0-1.2	122.D041	122.D041



Liner	Ø	305/355 for 3 m	305/355 for 4 m	305/355 for 5 m	405 for 3 m	405 for 4 m	405 for 5 m
Insulated liner	Ø 0.8	124.0011	124.0012	124.0015	-	-	-
	Ø 1.0	124.0026	124.0031	124.0035	124.D113	124.D114	124.D115
	Ø 1.2	124.0026**	124.0031**	124.0035**	124.D116***	124.D117***	124.D118***
	Ø 1.6	124.0041	124.0042	124.0044	124.D119	124.D120	124.D121

For more liner see chapter "Accessories & special equipment"

Standard equipment

* Included in the standard equipment for complete torches ABIMIG® A T 305 LW

** Included in the standard equipment for complete torches ABIMIG® A T 355 LW

*** Included in the standard equipment for complete torches ABIMIG® A T 405 LW

MIG/MAG WELDING TORCHES **ABIMIG® A T S LW**

ABIMIG® A T 155 S LW ■ **ABIMIG® A T 255 S LW**

ABIMIG® A T 355 S LW



All documents in one place: ABIDOC

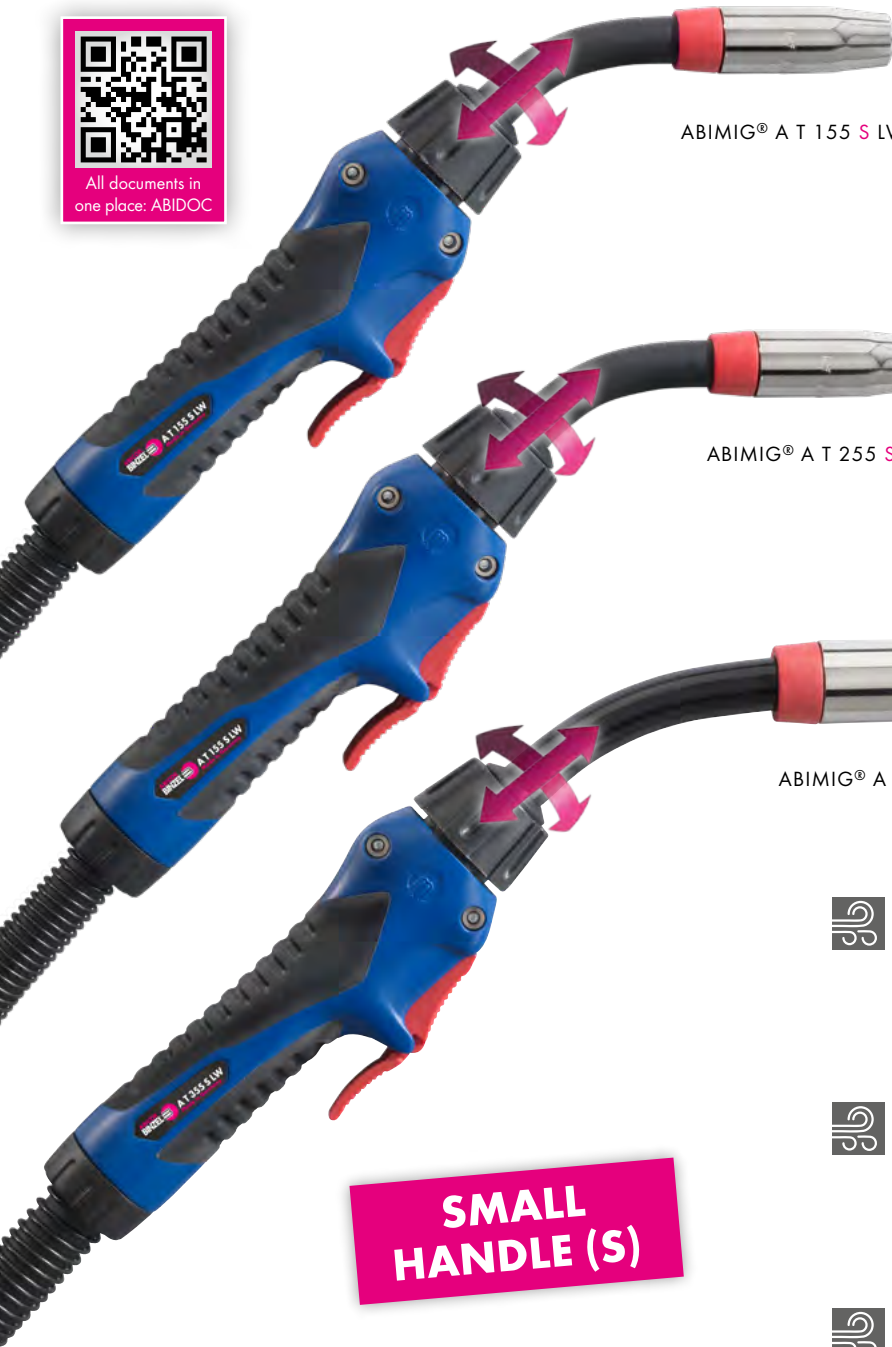

ABIMIG® A T 155 S LW

ABIMIG® A T 255 S LW

ABIMIG® A T 355 S LW

SMALL HANDLE (S)

160 – 320 A

Definition:

T = turnable/exchangeable torch neck
LW = lightweight cable assembly



ABIMIG® A T 155 S LW

Rating: 160 A CO₂
160 A Mixed gas M21*
Duty cycle: 60%
Wire Ø: 0.8–1.0 mm



ABIMIG® A T 255 S LW

Rating: 210 A CO₂
210 A Mixed gas M21*
Duty cycle: 60%
Wire Ø: 0.8–1.2 mm



ABIMIG® A T 355 S LW

Rating: 320 A CO₂
300 A Mixed gas M21*
Duty cycle: 60%
Wire Ø: 1.0–1.6 mm

Torch Type	Cooling	Part-No.			Torch neck	
		3 m	4 m	5 m	Type	Part-No.
ABIMIG® A T 155 S LW	gas cooled	006.0201.1	006.0202.1	006.0203.1	45°	006.D804.1
ABIMIG® A T 255 S LW	gas cooled	004.0792.1	004.0793.1	004.0794.1	45°	004.D831.1
ABIMIG® A T 355 S LW	gas cooled	014.0718.1	014.0719.1	014.0720.1	45°	014.H356.1
Base torch ABIMIG® A T G 155 S LW**	gas cooled	006.0204.1	006.0205.1	006.0206.1	from page 72	
Base torch ABIMIG® A T G 255 S LW**	gas cooled	004.0795.1	004.0796.1	004.0797.1	from page 72	
Base torch ABIMIG® A T G 355 S LW**	gas cooled	014.0723.1	014.0724.1	014.0725.1	from page 72	

Technical data according to EN 60 974-7 ■ DIN EN ISO 14175 ■ ** A T G = Base torch without torch neck

Wear parts

ABIMIG® A T 155 S LW

ABIMIG® A T 255 S LW

ABIMIG® A T 355 S LW

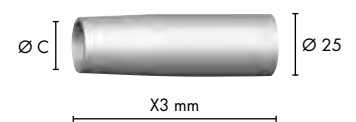
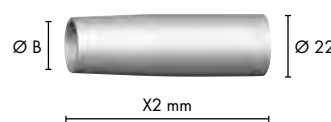
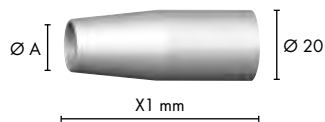

Gas nozzle (5 pcs.)	Ø A	X1		Ø B	X2		Ø C	X3	
Cylindrical	Ø 17	52 mm	145.D003.5	Ø 18	69 mm	145.D014.5	Ø 21	71 mm	145.D024.5
Conical	Ø 12	52 mm	145.D001.5*	Ø 16	70 mm	145.D011.5**	Ø 18	72 mm	145.D021.5**
Tapered	Ø 10	52 mm	145.D006.5	Ø 14	67 mm	145.D012.5	Ø 16	69 mm	145.D022.5

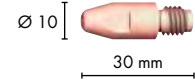
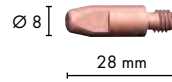
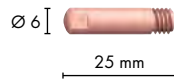

Contact tip (10 pcs.)		M6	M6	M8
E-Cu	Ø 0.8	140.0059*	140.0051	140.0114
	Ø 1.0	140.0253	140.0242**	140.0313
	Ø 1.2	-	140.0379	140.0442
	Ø 1.6	-	-	140.0587
CuCrZr	Ø 0.8	140.0062	140.0054	140.0117
	Ø 1.0	140.0256	140.0245	140.0316
	Ø 1.2	-	140.0382	140.0445**
	Ø 1.6	-	-	140.0590

For more contact tips see chapter "Accessories & special equipment"

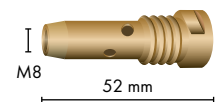
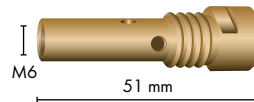
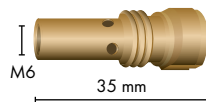

Contact tip holder (5 pcs.)	M6	M6	M8
	006.D719.5*	004.D624.5**	014.D745.5**



Adapter piece (5 pcs.)	767.D607.5*	767.D637.5**	767.D668.5**



Torch neck liners for T-torches				
Standard	Ø 0.8	122.D037* (5 pcs.)	122.D037 (5 pcs.)	122.D037 (5 pcs.)
	Ø 1.0	122.D038 (5 pcs.)	122.D038** (5 pcs.)	122.D038** (5 pcs.)
	Ø 1.2	-	122.D038 (5 pcs.)	122.D038** (5 pcs.)
	Ø 1.6	-	-	122.D045 (5 pcs.)
Brass for Al	Ø 0.8	122.D040	122.D040	122.D040
	Ø 1.0	122.D040	122.D041	122.D041
	Ø 1.2	-	122.D041	122.D041



Liners	Ø	for 3 m	for 4 m	for 5 m
Insulated liner	Ø 0.8	124.0011	124.0012	124.0015*
	Ø 1.0	124.0026**	124.0031**	124.0035**
	Ø 1.2	124.0026	124.0031	124.0035
	Ø 1.6	124.0041	124.0042	124.0044

For more liner see chapter "Accessories & special equipment"

Standard equipment

* Included in the standard equipment for complete torches ABIMIG® A T 155 S LW

** Included in the standard equipment for complete torches ABIMIG® A T 255 S LW

*** Included in the standard equipment for complete torches ABIMIG® A T 355 S LW



ABIMIG® A LW

MIG/MAG WELDING TORCHES **ABIMIG® A LW**



- **Particularly robust design**
- **Lightweight BIKOX® LW cable assembly**
- **Optional remote control modules**

Resilient lightweights: ABIMIG® A LW torches won't break that easily. The particularly robustly built torches with double-fixed torch neck are optimally protected against mechanical influences. Despite their sturdy design, they are especially easy to handle. The extra lightweight BIKOX® LW cable assembly reduces the weight and the optionally available remote control modules Up/Down, cross switch or rotary potentiometer allow quick adjustments.

ABIMIG® A LW advantages

- Particularly robust thanks to double torch neck fixation
- Lightweight cable assembly relieves the welder
- Comfortable due to selectable trigger length and remote control modules (optional)
- Universal contact tip holder for reduced wear part costs
- Longer service life due to screw-on, thermally insulated gas nozzle



DOUBLE-FIXED
TORCH NECK



MODULES
SEE PAGE 93

For special gas nozzles see chapter
"Accessories & special equipment"



UP TO
400 A

Type	Cooling	CO ₂	Mixed gas M21*	Duty cycle	Wire Ø
ABIMIG® A 155 LW	gas cooled	170 A	170 A	60%	0.8-1.0 mm
ABIMIG® A 255 LW	gas cooled	230 A	220 A	60%	0.8-1.2 mm
ABIMIG® A 305 LW	gas cooled	280 A	260 A	60%	0.8-1.2 mm
ABIMIG® A 355 LW	gas cooled	330 A	310 A	60%	1.0-1.6 mm
ABIMIG® A 405 LW	gas cooled	400 A	350 A	60%	1.0-1.6 mm

Technical data according to EN 60 974-7 ▪ DIN EN ISO 14175

MIG/MAG WELDING TORCHES **ABIMIG® A LW**

ABIMIG® A 155 LW ■ **ABIMIG® A 255 LW**



All documents in one place: ABIDOC



ABIMIG® A 155 LW

ABIMIG® A 255 LW



Optional control modules can be found on page 93.

170 – 230 A



ABIMIG® A 155 LW

Rating: 170 A CO₂
170 A Mixed gas M21*
Duty cycle: 60%
Wire Ø: 0.8–1.0 mm



ABIMIG® A 255 LW

Rating: 230 A CO₂
220 A Mixed gas M21*
Duty cycle: 60%
Wire Ø: 0.8–1.2 mm

Torch complete		Part-No.			Torch neck	
Type	Cooling	3 m	4 m	5 m	Type	Part-No.
ABIMIG® A 155 LW	gas cooled	767.0062.1	767.0063.1	767.0064.1	45°	767.0024.1
ABIMIG® A 255 LW	gas cooled	767.0065.1	767.0066.1	767.0067.1	45°	767.0027.1

Technical data according to EN 60 974-7 ■ *DIN EN ISO 14175

Wear parts

ABIMIG® A 155 LW

ABIMIG® A 255 LW

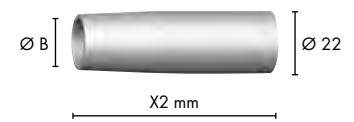
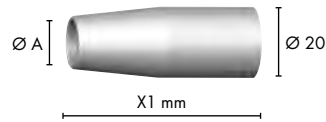

Gas nozzle (5 pcs.)	Ø A	X1		Ø B	X2	
Cylindrical	Ø 17	52 mm	145.D003.5	Ø 18	69 mm	145.D014.5
Conical	Ø 12	52 mm	145.D001.5*	Ø 16	70 mm	145.D011.5**
Tapered	Ø 10	52 mm	145.D006.5	Ø 14	67 mm	145.D012.5

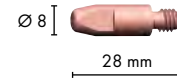
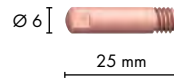

Contact tip (10 pcs.)		M6	M6
E-Cu	Ø 0.8	140.0059*	140.0051
	Ø 1.0	140.0253	140.0242**
	Ø 1.2	-	140.0379
CuCrZr	Ø 0.8	140.0062	140.0054
	Ø 1.0	140.0256	140.0245
	Ø 1.2	-	140.0382

For more contact tips see chapter "Accessories & special equipment"

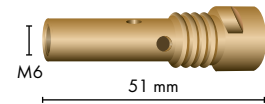
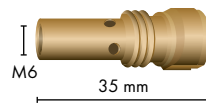

Contact tip holder (5 pcs.)		
M6	006.D719.5*	004.D624.5**



Adapter piece (5 pcs.)		
	767.D607.5*	767.D637.5**



Liner	Ø	for 3 m	for 4 m	for 5 m
Insulated liner	Ø 0.8	124.0011*	124.0012*	124.0015*
	Ø 1.0	124.0026**	124.0031**	124.0035**
	Ø 1.2	124.0026	124.0031	124.0035

For more liner see chapter "Accessories & special equipment"

Standard equipment

* Included in the standard equipment for complete torches ABIMIG® A 155 LW

** Included in the standard equipment for complete torches ABIMIG® A 255 LW

MIG/MAG WELDING TORCHES **ABIMIG® A LW**

ABIMIG® A 305 LW ■ **ABIMIG® A 355 LW**

ABIMIG® A 405 LW



All documents in
one place: ABIDOC



ABIMIG® A 305 LW

ABIMIG® A 355 LW

ABIMIG® A 405 LW



Optional control modules
can be found on page 93.

260–
400 A



ABIMIG® A 305 LW

Rating: 280 A CO₂
260 A Mixed gas M21*
Duty cycle: 60%
Wire Ø: 0.8–1.2 mm



ABIMIG® A 355 LW

Rating: 330 A CO₂
310 A Mixed gas M21*
Duty cycle: 60%
Wire Ø: 1.0–1.6 mm



ABIMIG® A 405 LW

Rating: 400 A CO₂
350 A Mixed gas M21*
Duty cycle: 60%
Wire Ø: 1.0–1.6 mm (up to 2.4 mm on request)

Torch complete		Part-No.			Torch neck	
Type	Cooling	3 m	4 m	5 m	Type	Part-No.
ABIMIG® A 305 LW	gas cooled	767.0068.1	767.0069.1	767.0070.1	45°	767.0045.1
ABIMIG® A 355 LW	gas cooled	767.0071.1	767.0072.1	767.0073.1	45°	767.0050.1
ABIMIG® A 405 LW	gas cooled	767.0074.1	767.0075.1	767.0076.1	45°	767.0055.1

Technical data according to EN 60 974-7 ■ *DIN EN ISO 14175

Wear parts

ABIMIG® A 305 / 355 LW

ABIMIG® A 405 LW

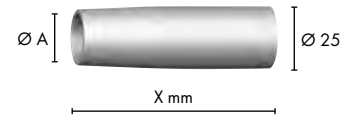
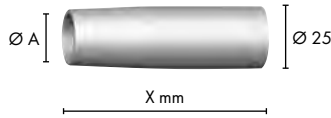

Gas nozzle (5 pcs.)	Ø A	X		Ø A	X	
Cylindrical	Ø 21	71 mm	145.D024.5	Ø 21	71 mm	145.D024.5
Conical	Ø 18	72 mm	145.D021.5**	Ø 18	72 mm	145.D021.5***
Tapered	Ø 16	69 mm	145.D022.5	Ø 16	69 mm	145.D022.5

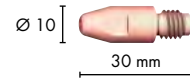
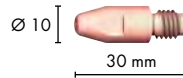

Contact tip (10 pcs.)		M8	M8
E-Cu	Ø 0.8	140.0114	140.0114
	Ø 1.0	140.0313	140.0313
	Ø 1.2	140.0442	140.0442
	Ø 1.6	140.0587	140.0587
CuCrZr	Ø 0.8	140.0117	-
	Ø 1.0	140.0316	140.0316
	Ø 1.2	140.0445**	140.0445
	Ø 1.6	140.0590	140.0590***

For more contact tips see chapter "Accessories & special equipment"

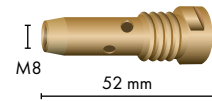
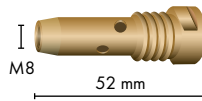

Contact tip holder (5 pcs.)		
M8	014.D745.5**	014.D745.5**



Adapter piece (5 pcs.)		
	767.0107.5**	015.D080.5***



Liner	Ø	305/355 for 3 m	305/355 for 4 m	305/355 for 5 m	405 for 3 m	405 for 4 m	405 for 5 m
Insulated liner	Ø 0.8	124.0011	124.0012	124.0015	-	-	-
	Ø 1.0	124.0026	124.0031	124.0035	124.D113	124.D114	124.D115
	Ø 1.2	124.0026**	124.0031**	124.0035**	124.D116***	124.D117***	124.D118***
	Ø 1.6	124.0041	124.0042	124.0044	124.D119	124.D120	124.D121

For more liner see chapter "Accessories & special equipment"

Standard equipment

- * Included in the standard equipment for complete torches ABIMIG® A 305 LW
- ** Included in the standard equipment for complete torches ABIMIG® A 355 LW
- *** Included in the standard equipment for complete torches ABIMIG® A 405 LW



STERSOAR
CE
EN 4793
WELDAS
STERSOAR 44-7142
SIZE 107cm LENGTH

ABIMIG® WT

MIG/MAG WELDING TORCHES **ABIMIG® W T**



- ✓ **Rotatable and exchangeable torch necks**
- ✓ **Large torch neck selection**
- ✓ **Small front end for optimal view**

Flexible all-rounders: Thanks to their rotatable and exchangeable torch necks, torches of the ABIMIG® W T series are extremely versatile. The wide selection of torch necks with different lengths and geometries ensures that even hard-to-access welding areas can be easily reached. Thanks to the compact design of the front end, they ensure a clear view of the welding process – regardless of the position. All available necks with the different power class 340, 440 and 540 can be used with the same base torch.

ABIMIG® W T advantages

- Powerful, liquid cooled torches
- Quick-change torch neck, reduced service times
- Flexible thanks to the rotatable torch necks in many lengths and shapes
- Small front end for optimal view of the process
- Longer service life thanks to gas nozzles with anti-spatter protection
- One base torch for all power classes (340, 440 and 540)



ROTATABLE AND EXCHANGEABLE TORCH NECKS



SMALL FRONTEND



UP/DOWN MODULE OPTIONAL

For special torch necks & gas nozzles see chapter "Accessories & special equipment"



Type	Cooling	CO ₂	Mixed gas M21*	Duty cycle	Wire Ø
ABIMIG® W T 340	liquid cooled	400 A	350 A	100%	0.8 - 1.2 mm
ABIMIG® W T 440	liquid cooled	450 A	400 A	100%	0.8 - 1.6 mm
ABIMIG® W T 540	liquid cooled	550 A	500 A	100%	1.0 - 1.6 mm

Technical data according to EN 60 974-7 * DIN EN ISO 14175

MIG/MAG WELDING TORCHES **ABIMIG® W T**

ABIMIG® W T 340 ■ **ABIMIG® W T 440** ■ **ABIMIG® W T 540**



All documents in one place: ABIDOC

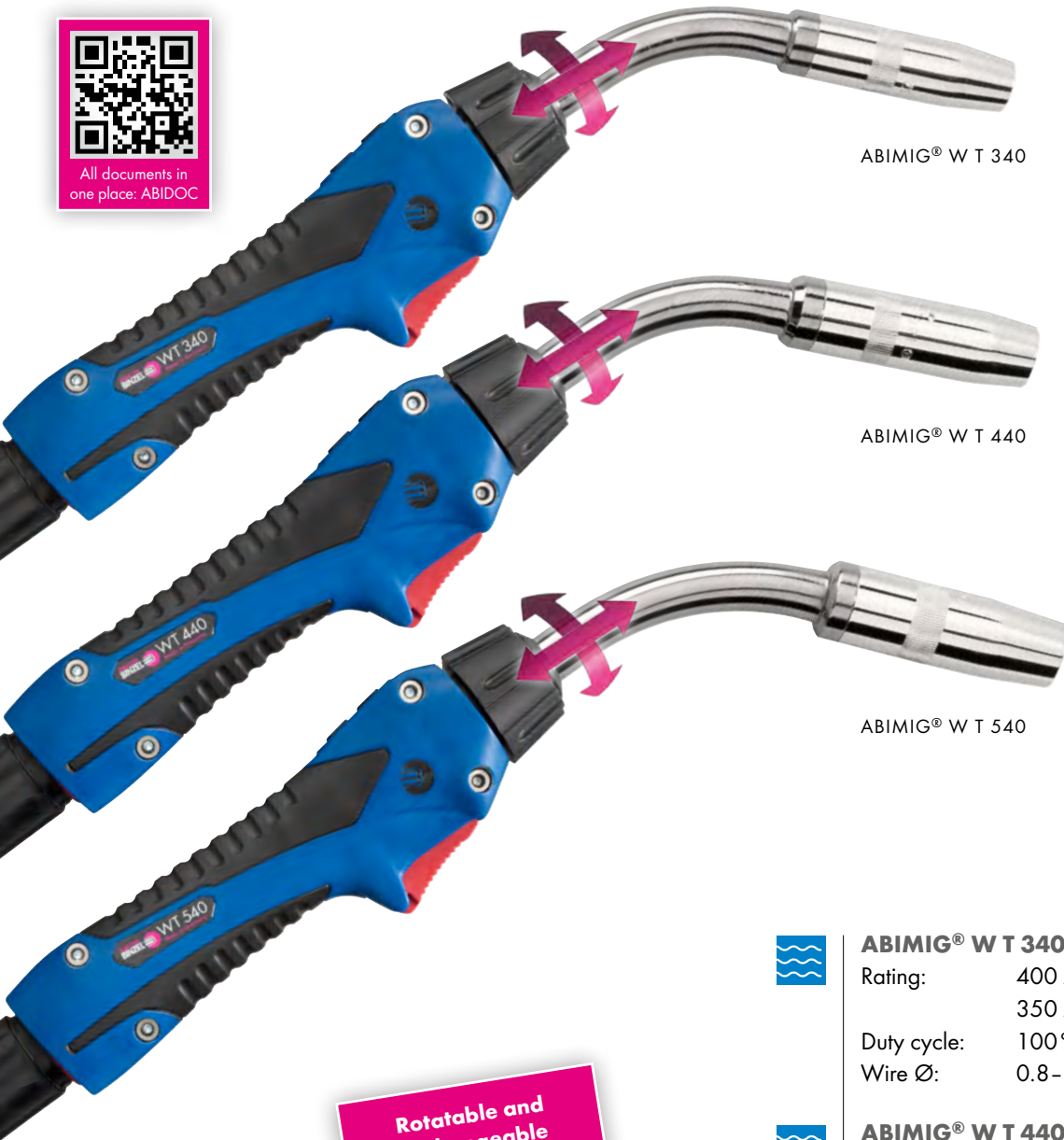

ABIMIG® W T 340

ABIMIG® W T 440

ABIMIG® W T 540

Rotatable and exchangeable torch necks

350–550 A

Note for liquid cooled torches:

To protect cable assembly components from excessive heat build up we recommend a post welding cooling cycle of at least 4 minutes.



ABIMIG® W T 340

Rating: 400 A CO₂
350 A Mixed gas M21*
Duty cycle: 100%
Wire Ø: 0.8–1.2 mm



ABIMIG® W T 440

Rating: 450 A CO₂
400 A Mixed gas M21*
Duty cycle: 100%
Wire Ø: 0.8–1.6 mm



ABIMIG® W T 540

Rating: 550 A CO₂
500 A Mixed gas M21*
Duty cycle: 100%
Wire Ø: 1.0–1.6 mm

Torch Type	Cooling	Part-No.			Torch neck	
		3 m	4 m	5 m	Type	Part-No.
ABIMIG® W T 340	liquid cooled	788.0116.1	788.0117.1	788.0118.1	50°	788.0020.1
ABIMIG® W T 440	liquid cooled	788.0119.1	788.0120.1	788.0121.1	50°	788.0005.1
ABIMIG® W T 540	liquid cooled	788.0122.1	788.0123.1	788.0124.1	50°	788.0026.1
Base torch ABIMIG® W T G**	liquid cooled	788.0110.1	788.0111.1	788.0112.1	see page 78	

Technical data according to EN 60 974-7 ■ *DIN EN ISO 14175 ■ **W T G = Base torch without torch neck

Wear parts

ABIMIG® W T 340

ABIMIG® W T 440

ABIMIG® W T 540



Gas nozzle incl. spatter protection ¹ (5 pcs.)	Ø A		Ø B		Ø C	
Cylindrical	Ø 17	145.0740.5	Ø 18	145.0745.5	Ø 20	145.0742.5
Conical	Ø 12.5	145.0737.5*	Ø 14.5	145.D092.5**	Ø 16	145.0735.5***
Conical	Ø 10	145.0739.5	Ø 12	145.0746.5	Ø 14	145.0741.5

The integrated spatter protection is already contained in the mentioned gas nozzles and can be ordered separately on request.

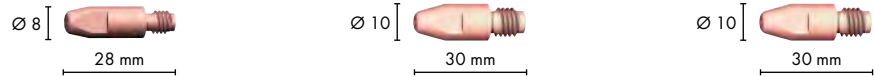

Contact tip (10 pcs.)		M6	M8	M8
E-Cu	Ø 0.8	140.0051	140.0114	-
	Ø 1.0	140.0242	140.0313	140.0313
	Ø 1.2	140.0379	140.0442	140.0442
	Ø 1.6	-	140.0587	140.0587
CuCrZr	Ø 0.8	140.0054	140.0117	-
	Ø 1.0	140.0245*	140.0316.10	140.0316
	Ø 1.2	140.0382	140.0445**	140.0445***
	Ø 1.6	-	140.0590	140.0590

For more contact tips see chapter "Accessories & special equipment"

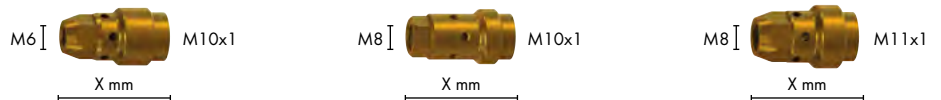

Contact tip holder (5 pcs.)	X		X		X	
Brass	24.0	142.0241.5	26.0	142.0252.5	25.0	142.0239.5
	26.0	142.0242.5*	28.0	142.0253.5**	27.0	142.0240.5
	-	-	31.0	142.0243.5	28.5	142.0284.5***



Torch neck liner						
Liner	Ø 0.8-1.2	123.D097*	123.D097**	123.D097***		
	Ø 1.4-1.6	-	123.D098	123.D098		
BPL liner with inlet-tip	Ø 0.8-1.2	149.0418.1	149.0418.1	149.0418.1		
	Ø 1.4-1.6	149.0420.1	149.0420.1	149.0420.1		



Liner	Ø	for 3 m	for 4 m	for 5 m
Insulated liner	Ø 0.8	124.0137	124.0138	124.0139
	Ø 1.0	124.0111*	124.0112*	124.0113*
	Ø 1.2	124.0111***	124.0112***	124.0113***
	Ø 1.6	124.0114	124.0115	124.0116

For more liner see chapter "Accessories & special equipment"

Standard equipment

* Included in the standard equipment for complete torches ABIMIG® W T 340

** Included in the standard equipment for complete torches ABIMIG® W T 440

*** Included in the standard equipment for complete torches ABIMIG® W T 540



ABIMIG® W

MIG/MAG WELDING TORCHES **ABIMIG® W**



- ✓ **Robust construction**
- ✓ **Small front end for optimal view**
- ✓ **Remote control modules (optional)**

Proven standard solution: The compact, liquid cooled ABIMIG® W torches with coated torch necks are ideally suited for welding with high welding currents and process temperatures. Thanks to the double-fixed torch necks they are robust in application. The compact front end allows a good view of the process. ABIMIG® W torches can be equipped with additional remote control modules on the handle if required.

ABIMIG® W advantages

- Particularly robust thanks to double torch neck fixation
- Powerful, liquid cooled torches
- Coated, screw-on nozzles with anti-spatter protection for long service lives
- High working comfort due to ergonomic handle



MODULES
SEE PAGE 93



DOUBLE-FIXED
TORCH NECK



SMALL FRONT END

For special gas nozzles see chapter
"Accessories & special equipment"



Type	Cooling	CO ₂	Mixed gas M21*	Duty cycle	Wire Ø
ABIMIG® W 340	liquid cooled	400 A	350 A	100%	0.8-1.2 mm
ABIMIG® W 440	liquid cooled	450 A	400 A	100%	0.8-1.6 mm
ABIMIG® W 540	liquid cooled	550 A	500 A	100%	1.0-1.6 mm

Technical data according to EN 60 974-7 ▪ DIN EN ISO 14175

MIG/MAG WELDING TORCHES **ABIMIG® W**

ABIMIG® W 340 ■ **ABIMIG® W 440** ■ **ABIMIG® W 540**



All documents in one place: ABIDOC



ABIMIG® W 340

ABIMIG® W 440

ABIMIG® W 540



Optional control modules can be found on page 93.

350-550 A

Note for liquid cooled torches:

To protect cable assembly components from excessive heat build up we recommend a post welding cooling cycle of at least 4 minutes.



ABIMIG® W 340

Rating: 400 A CO₂
350 A Mixed gas M21*
Duty cycle: 100%
Wire Ø: 0.8-1.2 mm



ABIMIG® W 440

Rating: 450 A CO₂
400 A Mixed gas M21*
Duty cycle: 100%
Wire Ø: 0.8-1.6 mm



ABIMIG® W 540

Rating: 550 A CO₂
500 A Mixed gas M21*
Duty cycle: 100%
Wire Ø: 1.0-1.6 mm

Torch complete		Part-No.			Torch neck	
Type	Cooling	3 m	4 m	5 m	Type	Part-No.
ABIMIG® W 340	liquid cooled	766.1558.1	766.1559.1	766.1560.1	50°	766.1553.1
ABIMIG® W 440	liquid cooled	766.1561.1	766.1562.1	766.1563.1	50°	766.1548.1
ABIMIG® W 540	liquid cooled	766.1564.1	766.1565.1	766.1566.1	50°	766.1539.1

Technical data according to EN 60 974-7 ■ DIN EN ISO 14175 ■ Up/Down module on request

Wear parts

ABIMIG® W 340

ABIMIG® W 440

ABIMIG® W 540



Gas nozzle incl. spatter protection ¹ (5 pcs.)	Ø A		Ø B		Ø C	
Cylindrical	Ø 17	145.0740.5	Ø 18	145.0745.5	Ø 20	145.0742.5
Conical	Ø 12.5	145.0737.5*	Ø 14.5	145.D092.5**	Ø 16	145.0735.5***
Conical	Ø 10	145.0739.5	Ø 12	145.0746.5	Ø 14	145.0741.5

The integrated spatter protection is already contained in the mentioned gas nozzles and can be ordered separately on request.

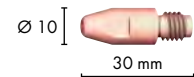
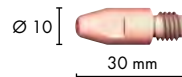
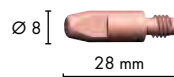

Contact tip (10 pcs.)		M6	M8	M8
E-Cu	Ø 0.8	140.0051	140.0114	-
	Ø 1.0	140.0242	140.0313	140.0313
	Ø 1.2	140.0379	140.0442	140.0442
	Ø 1.6	-	140.0587	140.0587
CuCrZr	Ø 0.8	140.0054	140.0117	-
	Ø 1.0	140.0245*	140.0316	140.0316
	Ø 1.2	140.0382	140.0445**	140.0445***
	Ø 1.6	-	140.0590	140.0590

For more contact tips see chapter "Accessories & special equipment"

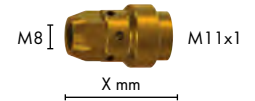
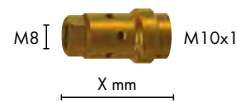
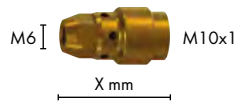

Contact tip holder (5 pcs.)	X		X		X	
Brass	24.0	142.0241.5	26.0	142.0252.5	25.0	142.0239.5
	26.0	142.0242.5*	28.0	142.0253.5**	27.0	142.0240.5
	-	-	31.0	142.0243.5	28.5	142.0284.5***



Liner	Ø	for 3 m	for 4 m	for 5 m
Insulated liner	Ø 0.8	124.0137	124.0138	124.0139
	Ø 1.0	124.0111*	124.0112*	124.0113*
	Ø 1.2	124.0111***	124.0112***	124.0113***
	Ø 1.6	124.0114	124.0115	124.0116

For more liner see chapter "Accessories & special equipment"

Standard equipment

* Included in the standard equipment for complete torches ABIMIG® W 340

** Included in the standard equipment for complete torches ABIMIG® W 440

*** Included in the standard equipment for complete torches ABIMIG® W 540



AUTOMATIC WELDING TORCHES

MIG/MAG AUTOMATIC WELDING TORCHES

ABIMIG® MT A T ■ ABIMIG® MT W T ■ ABIMIG® MT W



- ✓ Fixed or exchangeable torch neck
- ✓ Optional MB or ABIMIG® wear parts
- ✓ Cable assemblies in standard and special lengths

The automated ones: The powerful automatic welding torches offer highest precision and productivity. They combine proven and standardised torch technology with flexible special solutions. Thanks to the large selection of wear parts compatible with the manual welding torches, as well as different cable assembly lengths and torch neck geometries, they can be adapted to almost every welding task as required.

Advantages MIG/MAG automatic welding torches

- Robust, durable construction
- Short set-up and service times with exchangeable torch neck (ABIMIG®)
- Customised special torches
- Long service life and low storage thanks to MB and ABIMIG® wear parts
- Narrow front end (ABIMIG® MT W and WT) for optimal accessibility

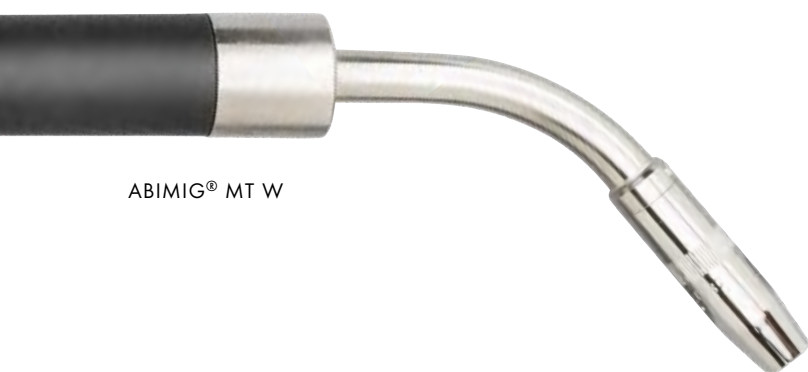

ABIMIG® MT W



ABIMIG® MT A T

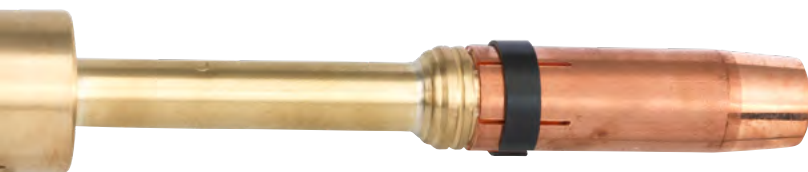

AUT 501 D



AUT 36 KD



MACHINE TORCHES ■ FIXED TORCH NECK

Fixed torch neck

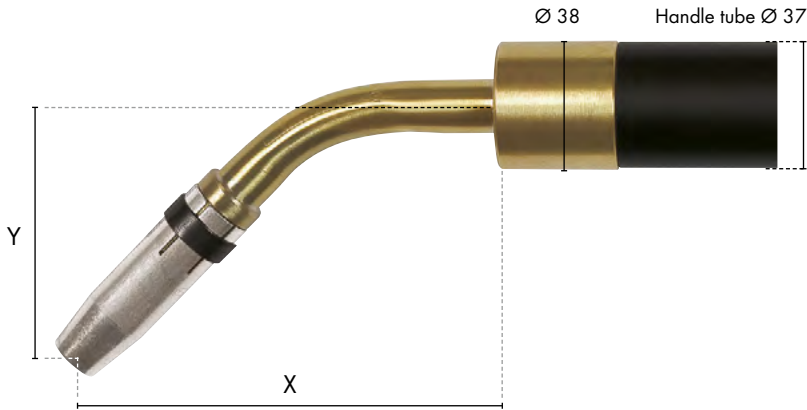

Order note

When ordering complete torches, please indicate the torch type, torch geometry (straight or bent) and dimension "L" (see sketch).

The wear parts – contact tip, gas nozzle, gas diffuser, contact tip holder, neck liner or liner – are identical with those of the manual welding torches of same size.



Torch mount MT37

for handle tubes Ø 37 mm
Part-no. 780.0260

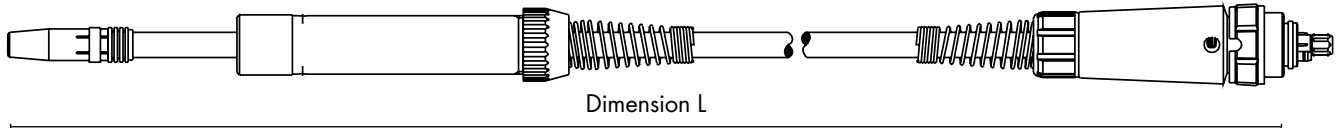

MB torches gas cooled**				Rating		Part-No.			
Type	Angle	X (mm)	Y (mm)	CO ₂	M21*	2 m	3 m	4 m	Torch neck
AUT 24KD	0°	154	-	250 A	220 A	912.0008	912.0009	912.0022	912.0001
AUT 24KD	45°	125	80	250 A	220 A	912.0011	912.0012	912.0023	912.0002
AUT 25AK	0°	140	-	230 A	200 A	904.0021	904.0026	904.0046	904.0003
AUT 25AK	45°	110	75	230 A	200 A	904.0022	904.0027	904.0058	904.0004
AUT 36KD	0°	185	-	320 A	290 A	914.0008	914.0013	914.0015	914.0002
AUT 36KD	45°	145	95	320 A	290 A	914.0009	914.0014	914.0028	914.0001

*Technical data according to EN 60 974-7 ■ Duty cycle 60% ■ **Handle tube Ø 37 mm

MB torches liquid cooled**				Rating		Part-No.			
Type	Angle	X (mm)	Y (mm)	CO ₂	M21*	2 m	3 m	4 m	Torch neck
AUT 240D	0°	154	-	300 A	270 A	923.0004	923.0005	923.0006	923.0001
AUT 240D	45°	126	73	300 A	270 A	923.0008	923.0009	923.0010	923.0002
AUT 501D	0°	167	-	500 A	450 A	934.0027	934.0032	934.0038	934.0001
AUT 501D	45°	135	82	500 A	450 A	934.0028	934.0033	934.0039	934.0002
MT W 555D	0°	175	-	550 A	500 A	766.0938.1	766.1434.1	766.0951.1	766.0865.1
MT W 555D	45°	144	84	550 A	500 A	766.1580.1	766.1436.1	766.1742.1	766.0867.1

*Technical data according to EN 60 974-7 ■ Duty cycle 100% ■ **Handle tube Ø 37 mm

ABIMIG® torches liquid cooled**				Rating		Part-No.		
Type	Angle	X (mm)	Y (mm)	CO ₂	M21*	Length (L)	Complete torch	Torch neck
ABIMIG® MT W 340	50°	135	85	300 A	270 A	2 m	766.1641.1	766.1645.1
ABIMIG® MT W 440	50°	140	85	450 A	400 A	2 m	766.1642.1	766.1650.1
ABIMIG® MT W 440	50°	140	85	450 A	400 A	5 m	766.1827.1	766.1650.1
ABIMIG® MT W 540	25°	185	40	550 A	500 A	3 m	766.1853.1	766.1854.1
ABIMIG® MT W 540	50°	155	90	550 A	500 A	2 m	766.1643.1	766.1654.1
ABIMIG® MT W 540	50°	155	90	550 A	500 A	3 m	766.1801.1	766.1654.1

*Technical data according to EN 60 974-7 ■ Duty cycle 100% ■ **Handle tube Ø 37 mm

MACHINE TORCHES ■ CHANGEABLE TORCH NECK

ABIMIG® MT A T – gas cooled with changeable torch neck interface

Base torch ABIMIG® MTG A T with changeable torch neck interface

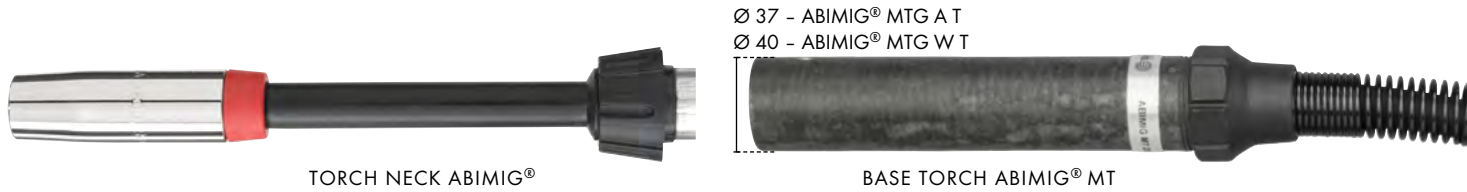

TORCH NECK ABIMIG®

BASE TORCH ABIMIG® MT



Torch mount MT40

for handle tubes Ø 40 mm

Bestellnr. 780.0259.1



Torch mount MT37

for handle tubes Ø 37 mm

Part-no. 780.0260

Base torch ABIMIG® MTG A T gas cooled with changeable torch neck interface **	Rating			Part-No.	
	CO ₂	M21*	DC	3 m	4 m
ABIMIG® MTG 255	240 A	220 A	60%	904.D010.1	904.0079.1
ABIMIG® MTG 355	340 A	320 A	60%	914.D020.1	914.0071.1
ABIMIG® MTG 405 / 455	400 A	370 A	60%	916.D005.1	916.D006.1

*Technical data according to EN 60 974-7 ■ **Handle tube Ø 37 mm

Torch necks for base torch ABIMIG® MTG A T				Rating			Contact tip	Part-No. COMBI neck***
Type	Angle	X (mm)	Y (mm)	CO ₂	M21*	DC		
AT 255 T8 bent	45°	160	85	240 A	220 A	60%	M6/Ø1.0	004.0628.1
AT 255 T8 straight	0°	195	-	240 A	220 A	60%	M6/Ø1.0	004.0690.1
AT 355 T8M bent	45°	185	95	340 A	320 A	60%	M8/Ø1.2	014.0474.1
AT 355 T8M straight	0°	195	-	340 A	320 A	60%	M8/Ø1.2	014.0540.1
AT 405 T8M bent	45°	210	95	400 A	370 A	60%	M8/Ø1.6	015.0089.1
AT 405 T8M straight	0°	250	-	400 A	370 A	60%	M8/Ø1.6	015.0103.1
AT 455 T8M bent	45°	220	105	400 A	370 A	60%	M10/Ø1.2	016.D403.1
AT 455 T8M straight	0°	270	-	400 A	370 A	60%	M8/Ø1.6	016.0034.1

*Technical data according to EN 60 974-7 ■ ***COMBI neck equipped with contact tip, gas nozzle, neck liner

Base torch ABIMIG® MTG W T liquid cooled with changeable torch neck interface **	Part-No.			
	2 m	3 m	4 m	5 m
ABIMIG® MTG W T	933.0001.1	933.D007	933.0008.1	933.0009.1

*Technical data according to EN 60 974-7 ■ **Handle tube Ø 40 mm

Torch necks for base torch ABIMIG® MTG W T				Rating			Contact tip	Part-No. COMBI neck***
Type	Angle	X (mm)	Y (mm)	CO ₂	M21*	DC		
WT 340 straight	0°	170	-	350 A	300 A	100%	M6/Ø1.0	788.0127.1
WT 440 straight	0°	175	-	450 A	400 A	100%	M8/Ø1.2	788.0129.1
WT 540 straight	0°	190	-	550 A	500 A	100%	M8/Ø1.2	788.0133.1

*Technical data according to EN 60 974-7 ■ ***COMBI neck equipped with contact tip, gas nozzle, neck liner

Other torch neck geometries and additional special accessories see chapter "Accessories & special equipment MIG/MAG".

Legend:

- TM Rotatable 360 degrees with metal outer tube
- T8M Fixed in 8 positions, can be repositioned in 45 degree increments, metal outer tube
- MTG Base torch with changeable torch neck interface



PUSH-PULL PLUS

MIG/MAG WELDING TORCHES **PUSH-PULL PLUS**



- ✓ **For aluminum welding and thin wires**
- ✓ **Also ideal for long cable assemblies**
- ✓ **Screwable and rotatable torch necks**

Sensitive drivers: When welding thin aluminum or stainless steel wires, sensitivity is required. This is where torches of the Push-Pull Plus series are right in their element. They feed wires particularly gently and evenly. Thus, they are ideally suited for welding with sensitive wires and long cable assemblies. The speed of the powerful pull motor can be precisely adjusted via an optional potentiometer. The screwable torch necks, which can be rotated 360 degrees, ensure good welding comfort and short set-up times.

Push-Pull Plus advantages

- High-torque pull motor ensures consistent wire feed
- Contact pressure regulation directly at the torch
- Economical stock-keeping thanks to MB wear parts
- Ergonomic handle for fatigue-free welding
- Versatile use with gas or liquid cooling

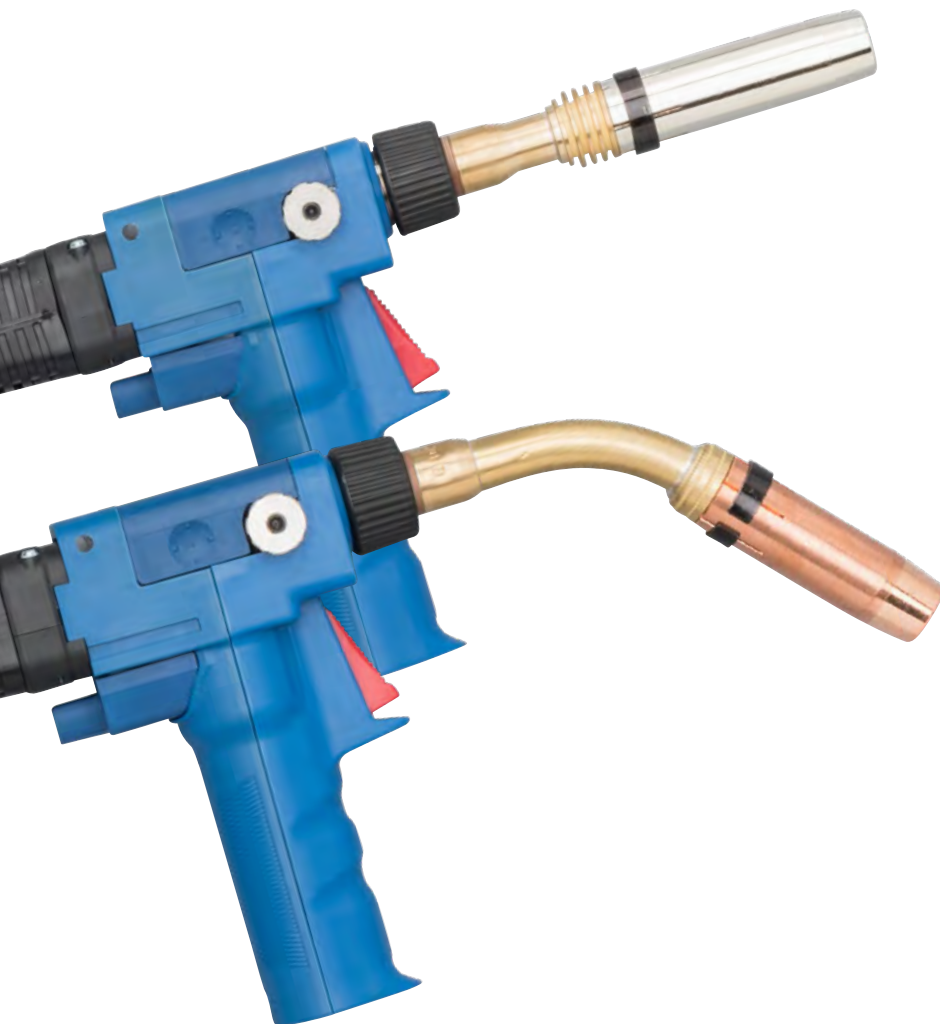

Type	Cooling	CO ₂	Mixed gas M21*	Duty cycle	Wire Ø
Push-Pull Plus 36 D	gas cooled	300 A	270 A	60%	0.8-1.2 mm
Push-Pull Plus 401 D	liquid cooled	400 A	350 A	100%	0.8-1.2 mm

Technical data according to EN 60 974-7 ▪ *DIN EN ISO 14175

MIG/MAG WELDING TORCHES **PUSH-PULL PLUS**

PUSH-PULL PLUS 36 D ■ PUSH-PULL PLUS 401 D



All documents in one place: ABIDOC



PUSH-PULL PLUS 36 D

PUSH-PULL PLUS 401 D



Push-Pull Plus 36 D

Rating: 300 A CO₂
270 A Mixed gas M21*

Duty cycle: 60%

Wire Ø: 0.8-1.2 mm



Push-Pull Plus 401 D

Rating: 400 A CO₂
350 A Mixed gas M21*

Duty cycle: 100%

Wire Ø: 0.8-1.2 mm

**270 –
400 A**

Note for liquid cooled torches:

To protect cable assembly components from excessive heat build up we recommend a post welding cooling cycle of at least 4 minutes.

Torch complete		Part-No.		Torch neck
Type	Model	8 m without poti	8 m with poti**	Part-No.
Push-Pull Plus 36 D	straight - EURO	085.0104.1	085.0106.1	085.0116.1
Push-Pull Plus 36 D	45° bent - EURO	085.0105.1	085.0107.1	085.0117.1
Push-Pull Plus 401 D	straight - EURO	095.0100.1	095.0114.1	095.0002
Push-Pull Plus 401 D	45° bent - EURO	095.0101.1	095.0115.1	095.0015

Wire feeding roll	Ø 0.8 mm	Ø 1.0 mm	Ø 1.2 mm
ST/AL	095.0064.1	095.0065.1	095.0066.1

Technical data according to EN 60 974-7 ■ *DIN EN ISO 14175 ■ **Poti 10 kΩ

Wear parts

Push-Pull Plus 36 D

Push-Pull Plus 401 D

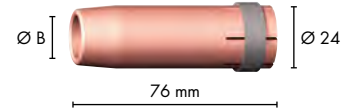
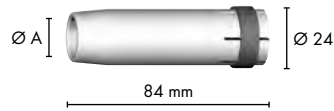

Gas nozzle (10 pcs.)	Ø A		Ø B	
Cylindrical	Ø 19	145.0045	Ø 20	145.0051
Conical	Ø 16	145.0078*	Ø 16	145.0085**
Tapered	Ø 12	145.0126	Ø 14	145.0132

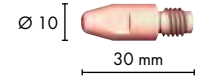
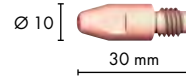
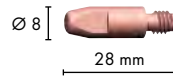

Contact tip (10 pcs.)		M6	M8	M6	M8
E-Cu	Ø 0.8	140.0051	140.0114	140.0051	140.0114
	Ø 1.0	140.0242	140.0313	140.0242	140.0313
	Ø 1.2	140.0379	140.0442*	140.0379	140.0442**
E-Cu for Al	Ø 0.8	141.0001	141.0003	141.0001	141.0003
	Ø 1.0	141.0006	141.0008	141.0006	141.0008
	Ø 1.2	141.0010	141.0015	141.0010	141.0015
CuCrZr	Ø 0.8	140.0054	140.0117	140.0054	140.0117
	Ø 1.0	140.0245	140.0316	140.0245	140.0316
	Ø 1.2	140.0382	140.0445	140.0382	140.0445

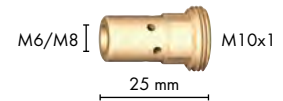

Contact tip holder (10 pcs.)		
M6	142.0005	142.0008
M8	142.0020*	142.0022**



Gas diffusor (10 pcs.)		
Standard	014.0748.10*	030.0265.10**
Long life	014.0026	030.0255.10
Ceramic	014.0023	030.0190



Liner		
Neck liner 0.8-1.0 mm***	149.0260.3	149.0264.3
Neck liner 1.2 mm***	149.0261.3*	149.0265.3**
Neck liner 0.8-1.0 mm****	149.0262.3	149.0266.3
Neck liner 1.2 mm****	149.0263.3*	149.0267.3**
Liner blank 0.8 mm	122.0010	122.0010
Liner blank 1.0-1.2 mm	122.0040	122.0040
Liner insulated 0.8 mm	124.0169	124.0169
PTFE liner 0.8 mm	126.0013	126.0013
PTFE liner 1.0-1.2 mm	126.0030	126.0030
Carbon PTFE liner 0.8 mm	127.0015	127.0015
Carbon PTFE liner 1.0-1.2 mm	127.0009	127.0009
PA liner 1.0-1.2 mm	128.0019*	128.0019*

*Included in the standard equipment for complete torches Push-Pull Plus 36 D ■ **Included in the standard equipment for complete torches Push-Pull Plus 401 D

For straight torch necks (0°) ■ *For bent torch necks (45°)



FreedomDrive

Part No.
IEC 60974.5/10 Class A

**ABICOR
BINZEL**

Alexander Binzel Schweißtechnik
GmbH & Co. KG · Knechtel
35418 Buseck · GERMANY

U ₁ =	2-20 m/min
I ₁ =	IP 20
I ₂ =	



OPEN

FREEDOMDRIVE

MIG/MAG PUSH-PULL SYSTEM **FREEDOMDRIVE**



- ✓ **Lightweight**
- ✓ **Also available for extraction torches**
- ✓ **Precise wire feeding**

Extend your working range up to 10 meters with the FreedomDrive push-pull system. This compact intermediate drive, used with ABIMIG® or xFUME® PRO manual torches, offers significantly lower handling weight and superior accessibility compared to conventional push-pull torches – just as you're used to with your standard manual torches.

FreedomDrive advantages

- Compact intermediate drive with lightweight ABIMIG® manual torches or xFUME® PRO extraction torches for good accessibility
- Liquid and gas cooled versions
- Optionally equipped with manual torches of the following torch series:
 - xFUME® – with extraction at the source
 - ABIMIG® A/W – with 10 kOhm potentiometer
 - ABIMIG® A T/W T – with rotatable and exchangeable torch neck
- Two driven rollers for precise wire feeding
- Internal routing of coolant and signal lines to avoid damage to external hoses



Type	Cooling	CO ₂	Mixed gas M21*	Duty cycle	Wire Ø
FreedomDrive ABIMIG® A 355 LW	gas cooled	330 A	310 A	60%	1.0-1.2 mm
FreedomDrive ABIMIG® A T 355 LW	gas cooled	340 A	320 A	60%	1.0-1.2 mm
FreedomDrive xFUME® 36	gas cooled	330 A	300 A	60%	1.0-1.2 mm
FreedomDrive ABIMIG® W 540	liquid cooled	500 A	450 A	100%	1.0-1.2 mm
FreedomDrive ABIMIG® W T 540	liquid cooled	500 A	450 A	100%	1.0-1.2 mm
FreedomDrive xFUME® 501	liquid cooled	500 A	450 A	100%	1.0-1.2 mm

Technical data according to EN 60 974-7 ▪ *DIN EN ISO 14175

MIG/MAG PUSH-PULL SYSTEM **FREEDOMDRIVE**

ABIMIG® A 355 LW ■ **ABIMIG® A T 355 LW**



All documents in one place: ABIDOC



1a ABIMIG® A 355 LW

1b ABIMIG® A T 355 LW



Also available as an extraction torch!
See our xFUME® catalog!

310 -
340 A

Definition:

T = turnable/exchangeable torch neck
LW = lightweight cable assembly



ABIMIG® A 355 LW (with poti 10 kΩ)

Rating: 330 A CO₂
310 A mixed gas M21*
Duty cycle: 60%
Wire Ø: 1.0-1.2 mm



ABIMIG® A T 355 LW

Rating: 340 A CO₂
320 A mixed gas M21*
Duty cycle: 60%
Wire Ø: 1.0-1.2 mm

Components			Part-No.	Torch neck	
Pos.	Description	Cooling		Type	Part-No.
1-4	Complete system incl. torch, ABIMIG® A 355 LW (with poti 10 kΩ)	gas cooled	095.0163.1**	45°	767.0050.1
1a	Torch without FreedomDrive, ABIMIG® A 355 LW (with Poti 10 kΩ)	gas cooled	767.0221.1***	45°	767.0050.1
1-4	Complete system incl. torch, ABIMIG® A T 355 LW	gas cooled	095.0162.1**	45°	014.H363.1
1b	Torch without FreedomDrive, ABIMIG® A T 355 LW	gas cooled	014.0762.1***	45°	014.H363.1
2	FreedomDrive intermediate drive	gas cooled	095.0161.1	-	-
3	Intermediate cable assembly	gas cooled	550.0361.1	-	-
4	Drive rolls combi for FreedomDrive, 1.0-1.2 mm (2 pcs.)	-	093.0182.2	-	-

Technical data according to EN 60 974-7 ■ *DIN EN ISO 14175 ■ **The complete system includes the respective torch, the intermediate cable assembly and a FreedomDrive.
***With special FreedomDrive machine connector.

Wear parts

ABIMIG® A 355 LW

ABIMIG® A T 355 LW

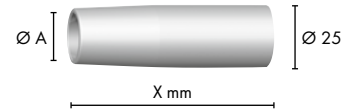
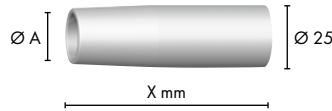

Gas nozzle (5 pcs.)	X	Part-No.	Ø A	X	Part-No.
Cylindrical	71 mm	145.D024.5	Ø 21	71 mm	145.D024.5
Conical	72 mm	145.D021.5*	Ø 18	72 mm	145.D021.5*
Tapered	69 mm	145.D022.5	Ø 16	69 mm	145.D022.5

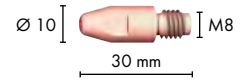
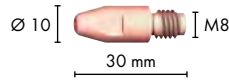

Contact tip (10 pcs.)	Ø	Part-No.	Ø	Part-No.
E-Cu	Ø 1.0	140.0313	Ø 1.0	140.0313
	Ø 1.2	140.0442	Ø 1.2	140.0442
CuCrZr	Ø 1.0	140.0316	Ø 1.0	140.0316
	Ø 1.2	140.0445*	Ø 1.2	140.0445*

For more contact tips see chapter "Accessories & special equipment"

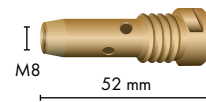
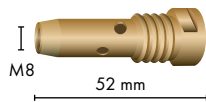

Contact tip holder (5 pcs.)	Part-No.	Part-No.
M8	014.D745.5*	014.D745.5*



Adapter piece (5 pcs.)	Part-No.	Part-No.
	767.0107.5*	767.D668.5*



Liner	Ø	Part-No.
Liner Intermediate cable assembly, carbon-PTFE, 2.0 x 4.0 x 8500 mm	Ø 1.0-1.2	127.0009*
Liner Intermediate cable assembly, PA, 2.3 mm x 4.7 mm x 8500 mm	Ø 1.0-1.2	128.0023
Combi liner, carbon-PTFE/brass, 2.0 mm x 4.0 mm x 3500 mm	Ø 1.0-1.2	127.M006*

Standard equipment

*Included in the standard equipment

MIG/MAG PUSH-PULL SYSTEM **FREEDOMDRIVE**

ABIMIG® W 540 ■ **ABIMIG® W T 540**



All documents in one place: ABIDOC



1a ABIMIG® W 540

1b ABIMIG® W T 540



Also available as an extraction torch!
See our xFUME® catalog!

450 – 500 A

Note for liquid cooled torches:

To protect cable assembly components from excessive heat build up we recommend a post welding cooling cycle of at least 4 minutes.



ABIMIG® W 540 (with poti 10 kΩ)

Rating: 500 A CO₂
450 A mixed gas M21*
Duty cycle: 100 %
Wire Ø: 1.0-1.2 mm



ABIMIG® W T 540

Rating: 500 A CO₂
450 A mixed gas M21*
Duty cycle: 100 %
Wire Ø: 1.0-1.2 mm

Components			Part-No.	Torch neck	
Pos.	Description	Cooling		Type	Part-No.
1-4	Complete system incl. torch, ABIMIG® W 540 (with Poti 10 kΩ)	liquid cooled	095.0159.1**	50°	766.1539.1
1a	Torch without FreedomDrive, ABIMIG® W 540 (with Poti 10 kΩ)	liquid cooled	766.1871.1***	50°	766.1539.1
1-4	Complete system incl. torch, ABIMIG® W T 540	liquid cooled	095.0166.1**	50°	788.0026.1
1b	Torch without FreedomDrive, ABIMIG® W T 540	liquid cooled	788.0355.1***	50°	788.0026.1
2	FreedomDrive intermediate drive	liquid cooled	095.0160.1	-	-
3	Intermediate cable assembly	liquid cooled	550.0355.1	-	-
4	Drive rolls combi for FreedomDrive, 1.0-1.2 mm (2 pcs.)	-	093.0182.2	-	-

Technical data according to EN 60 974-7 ■ *DIN EN ISO 14175 ■ **The complete system includes the respective torch, the intermediate cable assembly and a FreedomDrive.
***With special FreedomDrive machine connector.

Wear parts

ABIMIG® W 540

ABIMIG® W T 540

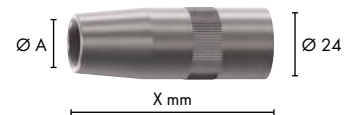

Gas nozzle (5 pcs.)	X	Part-No.	Ø A	X	Part-No.
Cylindrical	66 mm	145.0742.5	Ø 20	66 mm	145.0742.5
Conical	66 mm	145.0735.5*	Ø 16	66 mm	145.0735.5*
Tapered	66 mm	145.0741.5	Ø 14	66 mm	145.0741.5

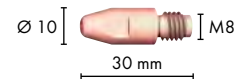
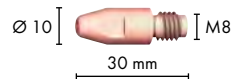

Contact tip (10 pcs.)	Ø	Part-No.	Ø	Part-No.
E-Cu	Ø 1,0	140.0313	Ø 1,0	140.0313
	Ø 1,2	140.0442	Ø 1,2	140.0442
E-Cu für Al	Ø 1,0	141.0003	Ø 1,0	141.0003
	Ø 1,2	141.0008	Ø 1,2	141.0008
CuCrZr	Ø 1,0	140.0316	Ø 1,0	140.0316
	Ø 1,2	140.0445*	Ø 1,2	140.0445*

For more contact tips see chapter "Accessories & special equipment"



Contact tip holder (5 pcs.)	X	Part-No.	X	Part-No.
Ms	25,0	142.0239.5	25,0	142.0239.5
	27,0	142.0240.5	27,0	142.0240.5
	28,5	142.0284.5*	28,5	142.0284.5*



Liner	Ø	Part-No.
Liner Intermediate cable assembly, carbon-PTFE, 2.0 x 4.0 x 8500 mm	Ø 1.0-1.2	127.0009*
Liner Intermediate cable assembly, PA, 2.3 mm x 4.7 mm x 8500 mm	Ø 1.0-1.2	128.0023
Combi liner, carbon-PTFE/brass, 2.0 mm x 4.0 mm x 3500 mm	Ø 1.0-1.2	127.M006*

Standard equipment

*Included in the standard equipment



ALPHA FLUX

MIG/MAG WELDING TORCHES **FLUX**

PRODUCTS FOR FCAW-S SELF-SHIELDING FLUX-CORED WIRES



- ✓ **Welding without shielding gas**
- ✓ **Various torch neck geometries**
- ✓ **ABIMIG® FLUX exchangeable necks for ABIMIG® torches**

The self-shielding ones:

ALPHA FLUX flux-cored welding wire torches for welding without shielding gas (FCAW) are robust and reliable tools for extreme conditions. For example, these torches are ideal for welding tasks in pipeline, piping and rail construction. The exchangeable torch necks, which can be rotated 360 degrees, enable ergonomic working in any position.

ABIMIG® FLUX exchangeable torch necks turn classic ABIMIG® AT MIG/MAG torches into fully functional welding torches for self-shielding flux cored wires. They are ideal for on-site repair and build-up welding.

ALPHA FLUX advantages

- Quick-change torch neck, reduced service times
- Welding down to -30°C with BIKOX® R coaxial cable
- Narrow gap systems (optional), ideal for rail repairs
- Coated contact tips: low spatter adhesion
- Extra comfort with welding power switch (optional)



ROTATABLE
TORCH NECK



OPTIONAL
TRIGGER



COATED
CONTACT TIP



UP TO
330 A

Type	Cooling	Rating	Duty cycle	Wire Ø
ALPHA FLUX 350	gas cooled	330 A	60%	1.2-2.4 mm

Technical data according to EN 60 974-7

FCAW-S WELDING TORCHES **FLUX**

ALPHA FLUX 350



All documents in one place: ABIDOC



ALPHA FLUX 350

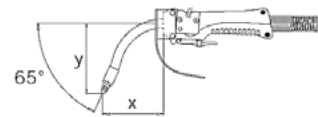

Torch neck	Geometry	Part-No.
65° bent (standard)	x = 108 mm y = 115 mm	013.D144

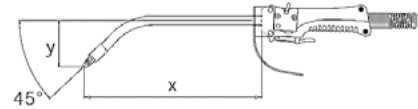

Torch neck	Geometry	Part-No.
45° bent	x = 280 mm y = 70 mm	013.D169

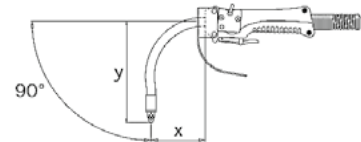

Torch neck	Geometry	Part-No.
90° bent	x = 85 mm y = 157 mm	013.D136

330 A



ALPHA FLUX 350

Rating: 330 A with self-shielding cored wire
 Duty cycle: 60%
 Wire Ø: 1.2-2.4 mm

Torch complete	Type	Special equipment	Part-No.	
			3 m	4.5 m
	ALPHA FLUX 350 KZ-2, EURO	-	013.D160	013.D161
	ALPHA FLUX 350 LN*	-	013.D152	013.D153
	ALPHA FLUX 350 KZ-2, EURO	with welding current switch**	013.D158	013.D159
	ALPHA FLUX 350 LN*	with welding current switch**	013.D164	013.D165

Technical data according to EN 60 974-7 ▪ *LN = applicable for wire feeding devices LINCOLN® ▪ **Control lead without plug for additional switch

ABIMIG® FLUX CHANGEABLE NECKS FCAW-S



Pos.	Description	Part-No.
1	Neck ABIMIG® FLUX 350 T, M8/65°	013.D177
1	Neck ABIMIG® FLUX 350 T8, M8/65°	013.D188
1	Neck ABIMIG® FLUX 350 T8, M8/40°	013.D218.1
2	Contact Tip M8/1.2/30 CuCrZr silver plated	147.0445
2	Contact Tip M8/1.4/30 CuCrZr silver plated	147.0536
2	Contact Tip M8/1.6/30 CuCrZr silver plated	147.0590
2	Contact Tip M8/2.0/30 CuCrZr silver plated	147.0656
3	Grub screw M8/4.0	013.D139
4	Sleeve D=3.5	013.D138
5	Ceramic Sleeve D=3.5	013.D137
6	Insulator 1 ALPHA FLUX	013.D132
7	PTFE Insulating Tube 14x12x143	013.D146
8	Neck liner 3.0 (wire Ø 1,2-2.0)	122.D110
9	Coupling nut M22x1,5/16	014.H279.1

Take the ABIMIG® FLUX necks to transform your MIG/MAG ABIMIG® A T exchangeable neck torch into a torch for self-shielding cored wire electrodes in just a few seconds.

Legend:

T 360° freely rotatable

T8 Torch neck fixed in 8 positions, can be repositioned in 45 degree increments

NARROW GAP SYSTEM FLUX PRO

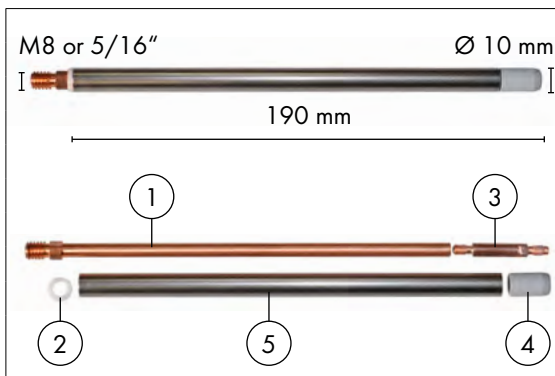

Position	Description	Part-No.
1-5	Narrow gap system FLUX PRO M8	528.0018.1
1-5	Narrow gap system FLUX PRO 5/16"	528.0012.1
1	Contact tube M8	528.0021.1
1	Contact tube 5/16"	528.0014.1
2	Insulating ring PTFE	528.0015.5
3	Contact tip DHCA/M5/1.6-2.0/35.2	528.0016.5
4	Insulating cap	528.0017.1
5	Protective tube	528.0013.1

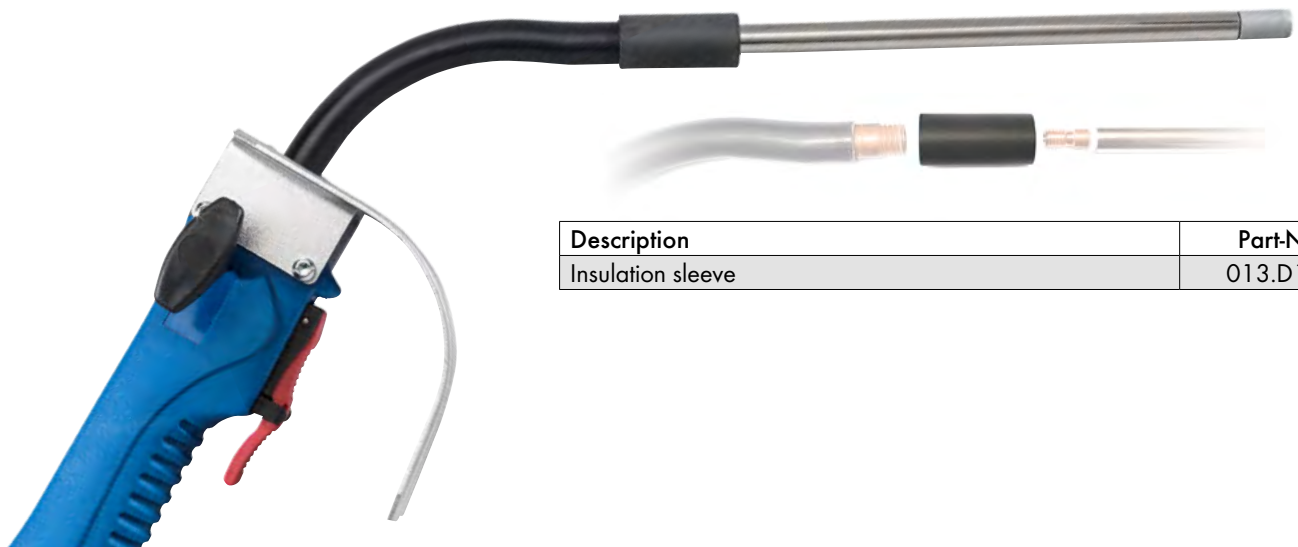

Description	Part-No.
Insulation sleeve	013.D155



ACCESSORIES MIG/MAG

ACCESSORIES & SPECIAL EQUIPMENT **MIG/MAG**



MIG/MAG welding torches are nothing without suitable accessories and special equipment:

These turn a good torch into a powerful tool that adapts to the welding task and ensures the best possible welding results at all times. The MB and ABIMIG® accessories range is optimally matched to the various welding torch series and offers suitable solutions for almost every welding challenge.

The high-quality original accessories and wear parts stand for optimum fitting accuracy, technically perfect adjustments and long-lasting quality. This means less downtime and reduced service times, as well as increased productivity.

		FROM PAGE
ACCESSORIES & SPECIAL EQUIPMENT	LINERS	68
	CONTACT TIPS	70
	FOR ABIMIG® A & ABIMIG® A T	72
	FOR ABIMIG® W & ABIMIG® W T	78
	FOR MB	82
	BIKOX® CABLES ■ CONTROL CABLES ■ HOSES HANDLES ■ MODULES	88 90

LINERS

- ✓ **Different materials**
- ✓ **Perfectly matched to different wires**
- ✓ **Different diameters and lengths**

Inner values: No matter whether liner, wire core or guide liner – they conduct the wire from the wire feeder through the cable assembly and torch neck to the contact tip and into the process. To ensure that this succeeds evenly and with low friction at all times, the liner must fit the welding wire. In addition, the internal diameter of the liner must be the right size for the welding wire. ABICOR BINZEL offers a wide range of metal and plastic liners as well as combination solutions for almost all welding wires.

Liner overview:

- Steel liner, insulated: versatile use, also for non-alloyed and low-alloyes SG steel wires
- Stainless steel liner BSL, insulated: for high-alloyed stainless steel wires
- PTFE liner: good gliding properties for aluminum, stainless steel and CuSi wires
- Carbon PTFE liner: best gliding properties for aluminum, stainless steel wires and special alloys
- BPL liner: for special wire types made of aluminum, special alloys, stainless steel and flux-cored wires
- PA liner: for all welding wires, only in combination with PTFE tip or brass liner, recommended for liquid cooled torches
- Combination wire feed carbon PTFE/brass: for aluminum or special wires
- Combination wire feed R: for aluminum or special wires



Liner Type	for wire Ø [mm]	Dimensions liner [mm]	Color code	Part-No.			
				for 3 m	for 4 m	for 5 m	for 8 m
Insulated steel liner, molded nipple, gas cooled	0.6-0.8	1.5 / 4.5	blue	124.0011	124.0012	124.0015	-
	1.0-1.2	2.0 / 4.5	red	124.0026	124.0031	124.0035	124.0169
	1.4-1.6	2.5 / 4.5	yellow	124.0041	124.0042	124.0044	-
Insulated steel liner, molded nipple, liquid cooled	0.6-0.8	1.5 / 4.5	blue	124.0137	124.0138	124.0139	-
	1.0-1.2	2.0 / 4.5	red	124.0111	124.0112	124.0113	124.0169
	1.4-1.6	2.5 / 4.5	yellow	124.0114	124.0115	124.0116	-
Stainless steel liner BSL insulated, molded nipple	0.8-1.2	2.0 / 4.5	pink	124.0105	124.0106	124.0107	-
	1.4-1.6	2.4 / 4.5	blue	124.0108	124.0109	-	-
PTFE liner	0.8-0.9	1.5 / 4.0	blue	126.0005	126.0008	126.0011	126.0013
	1.0-1.2	2.0 / 4.0	red	126.0021	126.0026	126.0028	126.0030
	1.2-1.6	2.5 / 4.7	yellow	126.0039	126.0042	126.0045	126.0047
Carbon PTFE liner	0.8-0.9	1.5 / 4.0	-	127.0002	127.0003	127.0004	-
	1.0-1.2	2.0 / 4.0	-	127.0005	127.0007	127.0008	127.0009
	1.4-1.6	2.7 / 4.7	-	127.0010	127.0012	127.0013	127.0014
PA liner	1.0-1.2	2.0 / 4.0	-	128.0012	128.0015	128.0016	128.0019
	1.2-1.4	2.3 / 4.7	-	128.0020	128.0021	128.0030	128.0023
	1.6-2.4	2.9 / 4.7	-	128.0024	128.0025	128.0027	128.0032
BPL liner with inlet tip	0.8-1.2	2.0 / 4.7	orange	126.0069	126.0070	126.0071	-
	1.4-1.6	2.7 / 4.7	petrol	126.0072	126.0073	126.0074	-
Combined wire guides PTFE/Brass	0.8-0.9	1.5 / 4.0	blue	126.M002	126.M003	126.M004	-
	1.0-1.2	2.0 / 4.0	red	126.M006	126.M007	126.M008	-
	1.2-1.6	2.5 / 4.7	yellow	126.M009	126.M010	126.M011	-
Combined wire guides Kohle PTFE/Brass	0.8-0.9	1.5 / 4.0	-	127.M002	127.M003	127.M004	-
	1.0-1.2	2.0 / 4.0	-	127.M006	127.M007	127.M008	-
Combined wire guides R (PA liner with graphite filling and PTFE inlet tip)	1.2-1.6	2.3 / 4.7	-	128.0077.1	128.0078.1	128.0079.1	128.0081.1

Special liner steel				Part-No.			
Type	for wire Ø	Dimensions liner	Color code	for 3 m	for 4 m	for 5 m	for 8 m
Steel liner blank with brass nipple*	0.6-0.8	1.5/4.0	-	122.0005	122.0007	122.0009	122.0010
	1.0-1.2	2.0/4.5	-	122.0031	122.0036	122.0039	122.0040
	1.4-1.6	2.5/4.5	-	122.0056	122.0060	122.0063	122.0065
Steel liner coated with brass nipple	0.6-0.8	1.5/4.5	blue	124.0126	124.0127	124.0128	-
	1.0-1.2	2.0/4.5	red	124.0129	124.0130	124.0131	124.0265.1
	1.4-1.6	2.5/4.5	yellow	124.0132	124.0133	124.0134	-

* Steel liner, bare: only for liquid cooled automatic torches, ABIMIG® GRIP, MB GRIP and MB ERGO torch lines

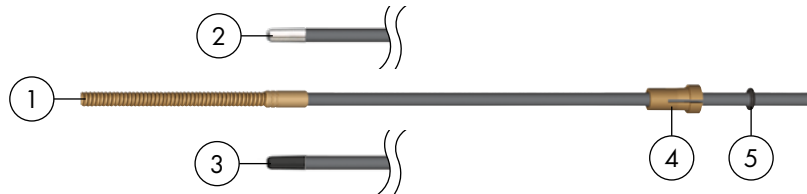

Accessories and spare parts for liners						
Pos.	Type	Description	for wire Ø	Dimensions liner	PU (pcs.)	Part-No.
1	Brass liner for combined wire guides	For liners with outside diameter 4.0 mm	0.8-0.9	1.8/4.4	10	001.0304
1	Brass liner for combined wire guides	For liners with outside diameter 4.0 mm	0.8-1.2	2.2/4.4	10	001.0305
1	Brass liner for combined wire guides	For liners with outside diameter 4.7 mm	1.2-1.6	2.2/4.4	10	001.0358
2	Stainless steel tip	For liners with outside diameter 4.0 mm. Only for liquid cooled torches. Thermal protection between liner and contact tip.	1.2-1.6	2.2/4.5	5	761.0104
3	PTFE tip	For liners with outside diameter 4.7 mm. Only for liquid cooled torches. Thermally insulating PTFE tip between PA liner and contact tip.	1.2-1.6	-	5	131.0066.5
4	Retaining nipple liner	For liners with outside diameter 4.0 mm	-	-	20	131.0001
4	Retaining nipple liner	For liners with outside diameter 4.5-4.7 mm	-	-	20	131.0002
5	O ring 3.5x1.5	For liners 4.0-5.0 mm	-	-	20	165.0008

Coil of liners					
Type	for wire Ø [mm]	Dimensions liner [mm]	Color code	Length	Part-No.
PTFE liner	0.8-0.9	1.5/4.0	blue	50 m	125.0004
PTFE liner	1.0-1.2	2.0/4.0	red	50 m	125.0006
PTFE liner	1.4-1.6	2.5/4.7	yellow	50 m	125.0017
Carbon PTFE liner	0.8-0.9	1.5/4.0	-	50 m	125.0005
Carbon PTFE liner	1.0-1.2	2.0/4.0	-	50 m	125.0007
Carbon PTFE liner	1.4-1.6	2.5/4.7	-	50 m	125.0018
PA liner	1.0-1.2	2.0/4.0	-	50 m	125.0008
PA liner	1.2-1.4	2.3/4.7	-	50 m	125.0016
PA liner	1.6-2.4	2.9/4.7	-	50 m	125.0019
BPL liner	0.8-1.2	2.0/4.7	orange	25 m	125.0026
BPL liner	1.4-1.6	2.7/4.7	petrol	25 m	125.0030
Steel liner blank	0.6-0.8	1.5/4.0	-	50 m	120.0009
Steel liner blank	1.0-1.2	2.0/4.5	-	50 m	120.0026
Steel liner blank	1.4-1.6	2.5/4.5	-	50 m	120.0045
Insulated steel liner	0.6-0.8	1.5/4.5	blue	50 m	123.0004
Insulated steel liner	1.0-1.2	2.0/4.5	red	50 m	123.0010
Insulated steel liner	1.4-1.6	2.5/4.5	yellow	50 m	123.0016
Insulated stainless steel liner BSL	0.8-1.2	2.0/4.5	pink	50 m	123.0026.50

CONTACT TIPS



- ✓ **High-quality materials**
- ✓ **Precise bore machining with the best surface quality**
- ✓ **Long service life**

Top seller: Contact tips are the core elements of MIG/MAG welding torches. They are responsible for the optimal power transmission, and the wire runs through them during the welding process. They are exposed to high loads from current, heat and friction and must be robust to ensure long service life. Original contact tips from ABICOR BINZEL made of high-quality materials are precisely manufactured and inspected. This ensures maximum process safety, reliable power transmission, long service lives and high availability of the welding torch.

The **E-Cu contact tip** guarantees excellent power transmission, good heat conduction, and good electrical conductivity. It has excellent process properties, but is less wear-resistant.

E-Cu contact tips for aluminum have a larger bore and thus can accommodate the greater expansion of aluminum wire when heated.

The **CuCrZr contact tip** is very hard and can withstand high thermal load due to the alloy elements chromium and zirconium. Its power transmission is good, and it offers excellent process properties with a low degree of wear.

The **CuCrZr silver-plated contact tip** combines the advantages of a CuCrZr contact tip with improved power transmission and reduced spatter adhesion on the coated surface.

The **HDS contact tip** has an internal core with greater hardness and special material formulation which leads to extreme heat and wear resistance. It is used for high currents and/or a high duty cycle. In the case of gas cooled applications with abrasive flux-cored wires, the HDS contact tip may have service lives up to four times longer. The standard silver plating reduces spatter adhesion and improves power transmission.

CONTACT TIPS OVERVIEW

Characteristics	E-Cu	E-Cu for aluminium	CuCrZr	CuCrZr silver-plated	HDS
Electrical conductivity	++	++	+	+	+
Temperature resistance	+	+	++	++	+++
Low spatter adhesion	+	+	+	++	++
Long service lives	+	+	++	++	+++

for torch types (10 pcs.)	for wire Ø (mm)	E-Cu	E-Cu for aluminium	CuCrZr	CuCrZr silver-plated	HDS
MB 15 ABIMIG® A/A T 155 	0.6	140.0008	-	140.0855	-	-
	0.8	140.0059	141.0002	140.0062	-	-
	0.9	140.0177	141.0005	140.0180	-	-
	1.0	140.0253	141.0007	140.0256	-	-
	1.2	140.0387	141.0011	140.0390	-	-

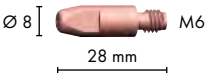
for torch types (10 pcs.)	for wire Ø (mm)	E-Cu	E-Cu for aluminium	CuCrZr	CuCrZr silver-plated	HDS
MB 24/25/26 ABIMIG® A/A T 255 ABIMIG® W/W T 340 	0.6	140.0005	-	-	-	-
	0.8	140.0051	141.0001	140.0054	-	-
	0.9	140.0169	141.0004	140.0172	147.0172	147.5172.10
	1.0	140.0242	141.0006	140.0245	147.0245	147.5245
	1.2	140.0379	141.0010	140.0382	147.0382	147.5382
	1.4	140.0516	141.0019	140.0519	147.0519	-
	1.6	140.0555	141.0020	140.0558	140.0558	-

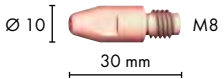
for torch types (10 pcs.)	for wire Ø (mm)	E-Cu	E-Cu for aluminium	CuCrZr	CuCrZr silver-plated	HDS
MB 36/401/501 D ABIMIG® A/A T 305/355/405/455 ABIMIG® W/W T 440/540 ABIMIG® GRIP W 555 D 	0.8	140.0114	141.0003	140.0117	-	-
	0.9	140.0214	-	140.0217	147.0217	-
	1.0	140.0313	141.0008	140.0316.10	147.0316	147.5316
	1.2	140.0442	141.0015	140.0445.10	147.0445	147.5445
	1.4	140.0533	141.0055	140.0536	147.0536	147.5536
	1.6	140.0587	141.0022	140.0590	147.0590	147.5590
	2.0	140.0653	141.0033	140.0656	147.0656	-
	2.4	140.0677	-	140.0679	-	-

ACCESSORIES & SPECIAL PARTS **ABIMIG® A/A T**

TORCH NECKS ABIMIG® A T

- ✓ **Low downtimes due to quick torch neck exchange**
- ✓ **Various geometries**
- ✓ **Rotatable 360 degrees**

The perfect fit ones: Torches must fit the welding task. Thanks to the standard interface with M22 x 1.5 thread, all ABIMIG® A T torch necks and basic torches can be combined as required. The ABIMIG® A/A T torches are available in different power classes with various geometries and rotation functions. When selecting the torch neck and basic torch, please ensure that the power specifications of the selected components match your welding task.

Variants

- T-model, rotatable 360 degrees with plastic outer tube
- TM-model, rotatable 360 degrees with metal outer tube
- T8M-model, fixed in 8 positions, can be repositioned in 45 degree increments, metal outer tube
- Combination neck model with neck liner, gas nozzle and contact tip
- Exchangeable neck model with contact tip holder, but without neck liner, gas nozzle and contact tip

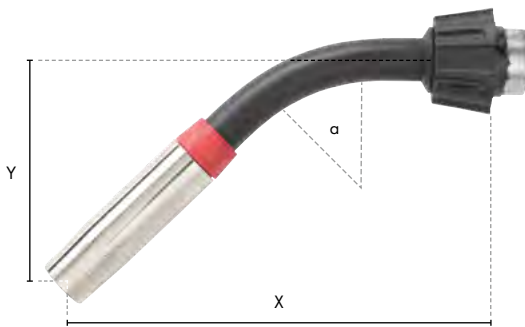

Torch necks ABIMIG® A T 155						
Type	Interface	α (angle)	X	Y	Part-No. COMBI neck*	Part-No. Torch neck**
AT 155 short	T	45°	105 mm	55 mm	006.0131.1	006.D848.1
AT 155 standard	T	45°	125 mm	70 mm	006.0132.1	006.D804.1
AT 155 60°	T	60°	155 mm	90 mm	006.0194.1	006.0191.1
AT 155 L	T	45°	305 mm	55 mm	006.0176.1	006.0171.1

*COMBI neck A T 155 each equipped with a neck liner and gas nozzle 155 ND12 and contact tip E-Cu M6/0.8

Torch necks ABIMIG® A T 255						
Type	Interface	α (angle)	X	Y	Part-No. COMBI neck*	Part-No. Torch neck**
AT 255 short	T	45°	125 mm	75 mm	004.0639.1	004.D837.1
AT 255 short metal	TM	45°	125 mm	75 mm	004.0638.1	004.D912.1
AT 255 standard	T	45°	160 mm	85 mm	004.0641.1	004.D831.1
AT 255 standard metal	TM	45°	160 mm	85 mm	004.0640.1	004.D842.1
AT 255 60° metal	TM	60°	135 mm	105 mm	004.0642.1	004.D860.1
AT 255 XL	T	45°	350 mm	85 mm	004.0631.1	004.0618.1
AT 255 XXL	T	45°	500 mm	85 mm	004.0736.1	004.0737.1
AT 255 straight	T8	0°	195 mm	-	004.0690.1	004.0691.1

*COMBI neck A T 255 each equipped with a neck liner and gas nozzle 255 ND16 and contact tip E-Cu M6/1.0

**Torch neck = with contact tip holder but without equipment: neck liner, gas nozzle and contact tip

Torch necks ABIMIG® A T 305 / 355

Type	Interface	α (angle)	X	Y	Part-No. COMBI neck*	Part-No. Torch neck**
AT 305 / 355 extra short	TM	45°	135 mm	75 mm	014.0467.1	014.H403.1
AT 305 / 355 short	TM	45°	160 mm	85 mm	014.0469.1	014.H356.1
AT 305 / 355 standard	TM	45°	185 mm	95 mm	014.0473.1	014.H363.1
AT 305 / 355 60°	TM	60°	165 mm	110 mm	014.0471.1	014.H413.1
AT 305 / 355 L	TM	45°	350 mm	95 mm	014.0475.1	014.H374.1
AT 305 / 355 XL	TM	45°	500 mm	95 mm	014.0477.1	014.H380.1
AT 305 / 355 extra short	T8M	45°	135 mm	75 mm	014.0468.1	014.H583.1
AT 305 / 355 short	T8M	45°	160 mm	85 mm	014.0470.1	014.H588.1
AT 305 / 355 standard	T8M	45°	185 mm	95 mm	014.0474.1	014.H370.1
AT 305 / 355 60°	T8M	60°	165 mm	110 mm	014.0472.1	014.H415.1
AT 305 / 355 straight	T8M	0°	195 mm	0 mm	014.0540.1	014.0541.1
AT 305 / 355 straight	T8M	0°	220 mm	0 mm	014.H570.1	014.H569.1

*COMBI neck A T 305 / 355 each equipped with a neck liner and gas nozzle 305/355/405 ND18 and contact tip CuCrZr M8/1.2

Torch necks ABIMIG® A T 405

Type	Interface	α (angle)	X	Y	Part-No. COMBI neck*	Part-No. Torch neck**
AT 405 short	T8M	45°	185 mm	95 mm	015.0088.1	015.D117.1
AT 405 standard	T8M	45°	210 mm	95 mm	015.0089.1	015.D082.1
AT 405 straight	T8M	0°	250 mm	-	015.0103.1	015.0104.1

*COMBI neck A T 405 each equipped with a neck liner and gas nozzle 305/355/405 ND18 and contact tip CuCrZr M8/1.6

Torch necks ABIMIG® A T 455

Type	Interface	α (angle)	X	Y	Part-No. COMBI neck*	Part-No. Torch neck**
AT 455 bent	T8M	45°	220 mm	105 mm	016.D403.1	016.D395.1
AT 455 straight	T8M	45°	270 mm	-	016.0034.1	016.0035.1

*COMBI neck A T 455 each equipped with a neck liner and gas nozzle 455 conical ND19 and contact tip CuCrZr

TORCH NECK LINER ABIMIG® A T



Torch neck liner

Type	Wire diameter	Standard length (torch neck x < 300 mm)	Special length (torch neck x > 300 mm)
Standard, steel	0.8 mm	122.D037	-
	1.0-1.2 mm	122.D038	122.D119.1
	1.6 mm	122.D045	122.D075
Brass, for aluminum and stainless steel	1.0 mm	122.D040	-
	1.0-1.2 mm	122.D041	on request

**Torch neck = with contact tip holder but without equipment: neck liner, gas nozzle and contact tip

ACCESSORIES & SPECIAL PARTS **ABIMIG® A/A T**

FLEXIBLE TORCH NECKS ABIMIG® A T

- ✓ Individually adjustable torch neck
- ✓ For frequently changing welding positions
- ✓ Various performance classes and lengths

The flexible ones: If the welding position changes frequently, flexible torch necks are the ideal solution. They can be bent quickly and easily into the desired position and hold it during the process. Furthermore, they ensure the best possible welding results and a good view at all times. They are available in different power classes and various lengths.

Variants

- Available in lengths between 230 and 500 mm
- Various power classes
- Combination necks AT 305 L and XL connect flexible and rigid parts
- Standard exchangeable neck interface M22 x 1.5 thread

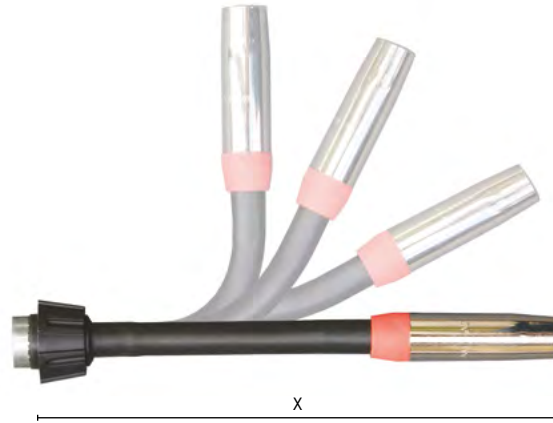

Flexible torch necks ABIMIG® A T				
Type	Contact tip	X	Rating CO ₂ / Mixed gas M21*	Part-No.
COMBI neck A T 155 Flex	M6	230	190 A / 180 A	006.0133.1
COMBI neck A T 255 Flex	M6	250	240 A / 220 A	004.0646.1
COMBI neck A T 305 Flex	M8	250	290 A / 260 A	018.0191.1
COMBI neck A T 405 Flex	M8	260	400 A / 370 A	015.0140.1

*DIN EN ISO 14175

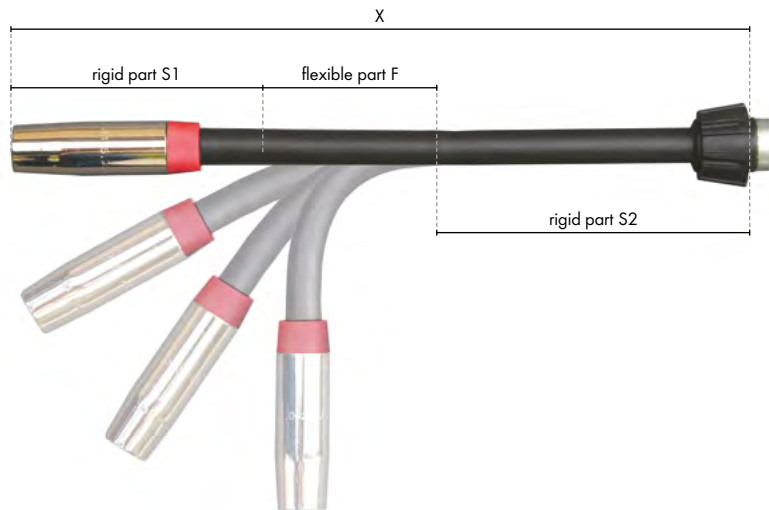

Flexible torch necks ABIMIG® A T (lengths L and XL)							
Type	Contact tip	X	S1	S2	F	Rating CO ₂ / Mixed gas M21*	Part-No.
COMBI neck A T 305 L Flex	M8	350	108	96	146	290 A / 260 A	018.0198.1
COMBI neck A T 305 XL Flex	M8	500	180	96	296	290 A / 260 A	018.0199.1

*DIN EN ISO 14175

SPECIAL TORCH NECK T AC Y33 ABIMIG® A T

- ✓ Extra short torch head
- ✓ Ideal for confined welding situations
- ✓ Different versions available

The compact ones: When installation space is limited or the welding position is difficult to reach, it is time for the extra compact special torch necks. These have an extra-short torch head and are available with different geometries and flexible designs.

Variants

- Different lengths and flexible version available
- Special contact tips and gas nozzles
- Standard exchangeable neck interface M22 x 1.5 thread

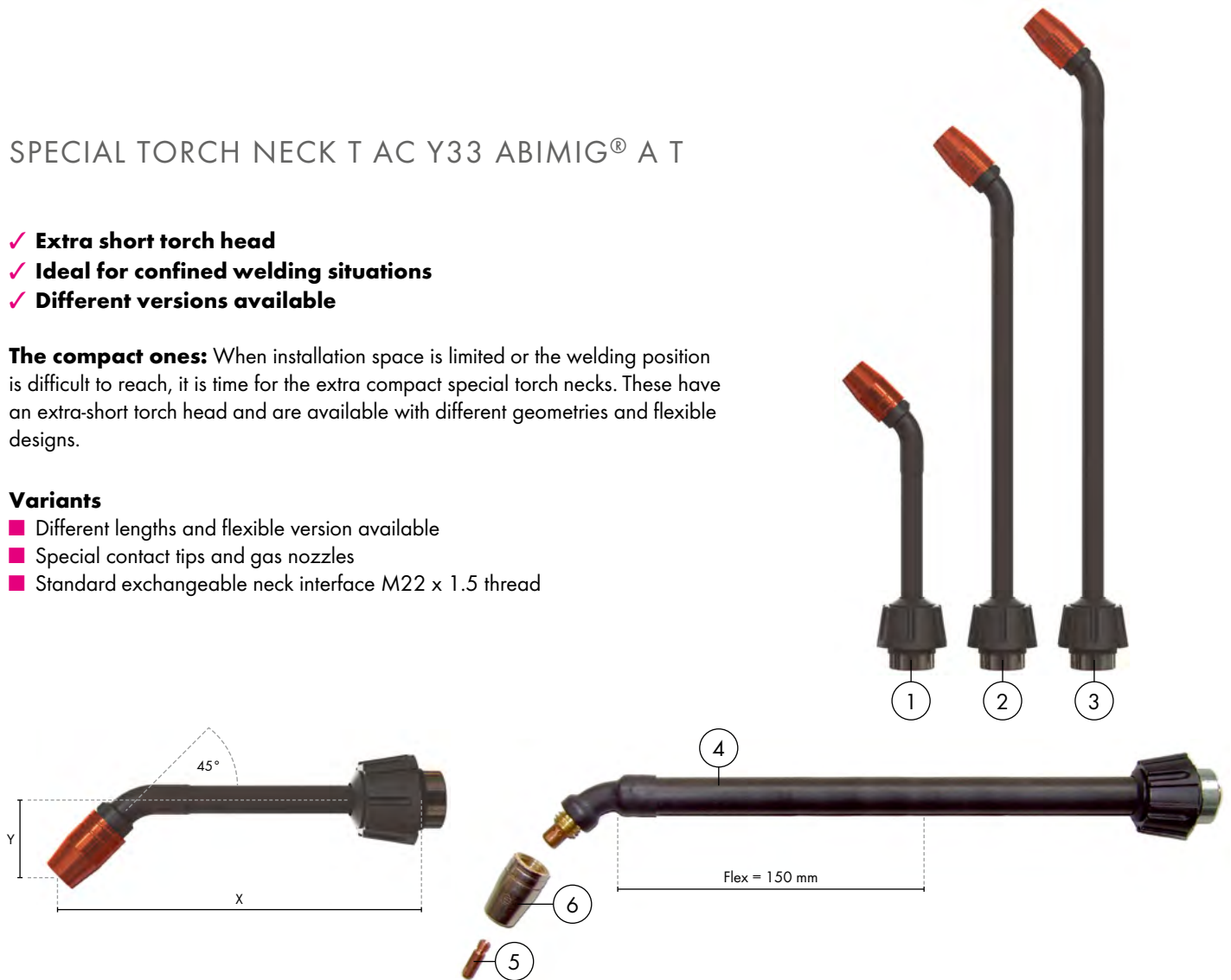

Special torch neck T AC Y33							
Position	Type	Angle	X	Y	PU (pcs.)	Part-No.	
1	Special torch neck T AC Y33	45°	155 mm	33 mm	1	006.D844.1	
2	Special torch neck T AC Y33	45°	285 mm	33 mm	1	006.D787	
3	Special torch neck T AC Y33	45°	350 mm	33 mm	1	006.D829.1	
4	Special torch neck T AC Y33 Flex	flexible	300 mm	-	1	006.0162.1	
	Equipment	Length	Ø				
-	Neck liner 2.0	265 mm	-	-	1	122.D038*	
-	Neck liner 2.0	415 mm	-	-	1	122.D088*	
5	Contact tip E-Cu M6/0.8/20	-	0.8	-	10	140.0043	
5	Contact tip E-Cu M6/1.0/20	-	1.0	-	10	140.0236*	
5	Contact tip E-Cu M6/1.2/20	-	1.2	-	10	140.0374	
5	Contact tip CuCrZr M6/0.8/20	-	0.8	-	10	140.0044	
5	Contact tip CuCrZr M6/1.0/20	-	1.0	-	10	140.1067	
5	Contact tip CuCrZr M6/1.2/20	-	1.2	-	10	140.1068	
6	Gas nozzle con. ND 13	-	-	-	10	145.0408.10*	

*Included in standard equipment

Special torch neck T AC Y33

Rating: 220 A CO₂
 200 A Mixed gas M21*
 Duty cycle: 60%
 Wire Ø: 0.8-1.2 mm

Technical data according to EN 60 974-7 ▪ *DIN EN ISO 14175

ACCESSORIES & SPECIAL PARTS **ABIMIG® A/A T**

GAS NOZZLES ABIMIG® A/A T

- ✓ **Thick walls**
- ✓ **Longer service lives**
- ✓ **Low spatter adhesion**

The durable ones: ABIMIG® high-performance gas nozzles have thick walls with a nickel-plated surface. This ensures particularly long service lives with reduced spatter adhesion and heat reflection, while at the same time providing optimal shielding gas coverage. They are available in different geometries and are matched to various torch types. Versions with extended insulation prevent bridging caused by welding spatter between gas nozzle and contact tip holder when welding vertical and overhead seams in forced positions.

Variants

- Conical and cylindrical nozzles
- For different welding torch types
- Versions with extended insulation

Legend:

ND	nominal diameter
R	contact tip recess
L1	length cone
L2	total length
G	thread
D	outside diameter
NI	nickel-plated
VI	long isolation
BL	blank surface Cu

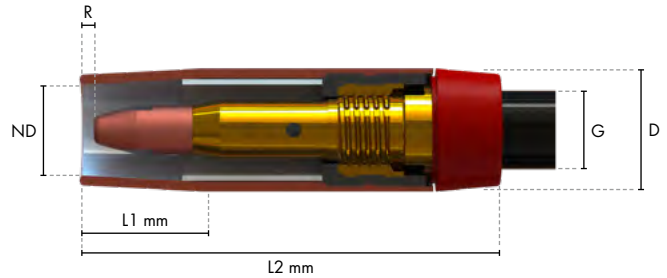

ABIMIG® A/A T 155									
Description	Surface	G	Shape	ND	D	L1	L2	R	Part-No.
Gas nozzle KON M12 ND10 L52	NI	M12	conical	10	20	26	52	0	145.D006
Gas nozzle KON M12 ND12 L52*	NI	M12	conical	12	20	25	52	0	145.D001
Gas nozzle KON M12 ND12 L52	BL	M12	conical	12	20	25	52	0	145.D186
Gas nozzle KON M12 ND12 L54	NI	M12	conical	12	20	25	54	-2	145.D004
Gas nozzle ZYL M12 ND17 L52	NI	M12	cylindrical	17	20	0	52	0	145.D003

ABIMIG® A/A T 255									
Description	Surface	G	Shape	ND	D	L1	L2	R	Part-No.
Gas nozzle KON M14 ND10 L67	NI	M14	conical	10	22	22	67	0	145.D268
Gas nozzle KON M14 ND12 L67	NI	M14	conical	12	22	30	67	0	145.D013
Gas nozzle KON M14 ND12 L70	NI	M14	conical	12	22	45	70	-3	145.D015
Gas nozzle KON M14 ND14 L67	NI	M14	conical	14	22	30	67	0	145.D012
Gas nozzle KON M14 ND14 L70	NI	M14	conical	14	22	30	70	-3	145.D016
Gas nozzle KON M14 ND16 L70*	NI	M14	conical	16	22	30	70	-3	145.D011
Gas nozzle KON M14 ND16 L70	BL	M14	conical	16	22	30	70	-3	145.D190
Gas nozzle ZYL M14 ND18 L69	NI	M14	cylindrical	18	22	0	69	0	145.D014
Gas nozzle KON M14 ND16 L70 VI	NI	M14	conical	16	22	20	70	-3	145.D195

ABIMIG® A/A T 305/355/405									
Description	Surface	G	Shape	ND	D	L1	L2	R	Part-No.
Gas nozzle KON M16 ND10 L69	NI	M16	conical	10	25	32	69	0	145.D267
Gas nozzle KON M16 ND12 L72	NI	M16	conical	12	25	34	72	-3	145.D025
Gas nozzle KON M16 ND14 L69	NI	M16	conical	14	25	26	69	0	145.D023
Gas nozzle KON M16 ND15 L72 VI	NI	M16	conical	15	25	23	72	-3	145.D217
Gas nozzle KON M16 ND16 L69	NI	M16	conical	16	25	30	69	0	145.D022
Gas nozzle KON M16 ND16 L72	NI	M16	conical	16	25	30	72	-3	145.D026
Gas nozzle KON M16 ND18 L72*	NI	M16	conical	18	25	30	72	-3	145.D021
Gas nozzle KON M16 ND18 L72	BL	M16	conical	18	25	30	72	-3	145.D036
Gas nozzle KON M16 ND18 L72 VI	NI	M16	conical	18	25	25	72	-3	145.D194
Gas nozzle ZYL M16 ND21 L71	NI	M16	cylindrical	21	25	0	71	-3	145.D024
Gas nozzle ZYL M16 ND21 L71 VI	NI	M16	cylindrical	21	25	0	71	-2	145.D353

*Standard equipment of the torch type

NARROW GAP GAS NOZZLES ABIMIG® A / A T

- ✓ **Tapered or bottle-shaped**
- ✓ **Ideal for working in narrow joints and gaps**
- ✓ **Time and material savings through narrow gap welding with less distortion**

The slim ones: ABICOR BINZEL narrow gap nozzles are specially designed for welding in joints and gaps. Bottle-shaped models with nickel-plated surface reduce spatter adhesion and reflect radiant heat. Tapered narrow gap nozzles are shaped strongly conical and allow a good view of the process and precise welding in narrow gaps.

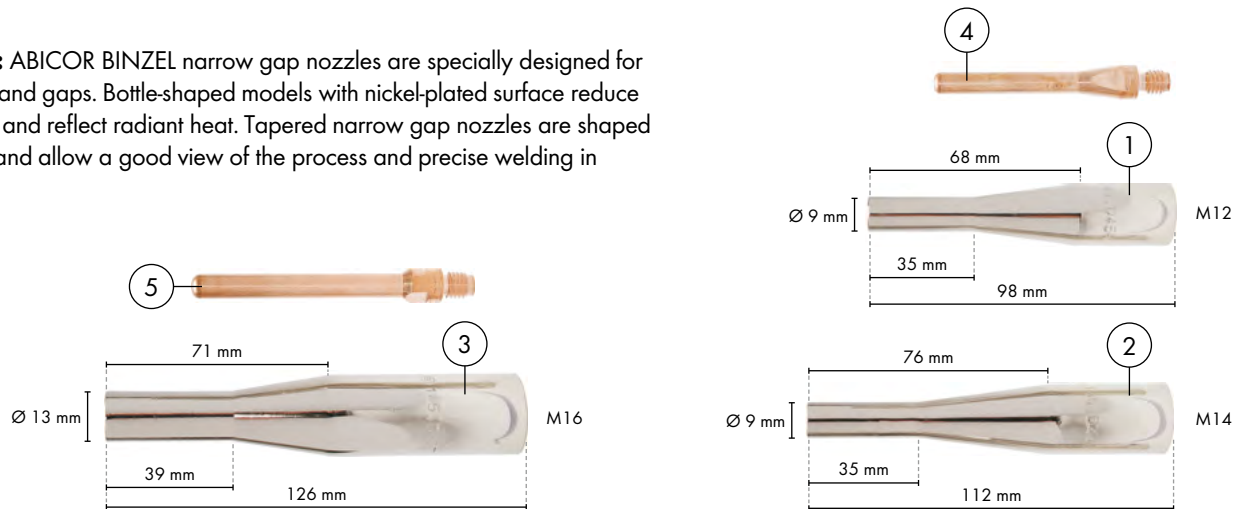

Gas nozzles and narrow gap gas nozzles for ABIMIG® A / A T

Position	Description	Torch type	PU (pcs.)	Part-No.
1	Gas nozzle BOT M12 ND9 L98	A/A T 155	5	145.D450.5
2	Gas nozzle BOT M14 ND9 L112	A/A T 255	5	145.D448.5
3	Gas nozzle BOT M16 ND13 L126	A/A T 305/355/405	5	145.D437.5
4	Contact tip CuCrZr M6/0.8/71	A/A T 155/255	10	140.1644.10
4	Contact tip CuCrZr M6/1.0/71	A/A T 155/255	10	140.D465.10
4	Contact tip CuCrZr M6/1.2/71	A/A T 155/255	10	140.D466.10
5	Contact tip CuCrZr M8/1.0/85	A/A T 305/355/405	10	140.1584.10
5	Contact tip CuCrZr M8/1.2/85	A/A T 305/355/405	10	140.1585.10

NARROW GAP GAS NOZZLE, TAPERED, ABIMIG® A / A T 305 / 355 / 405

The strongly conical narrow-gap pointed gas nozzle enables a good view of the process and thus precise work in narrow gaps.

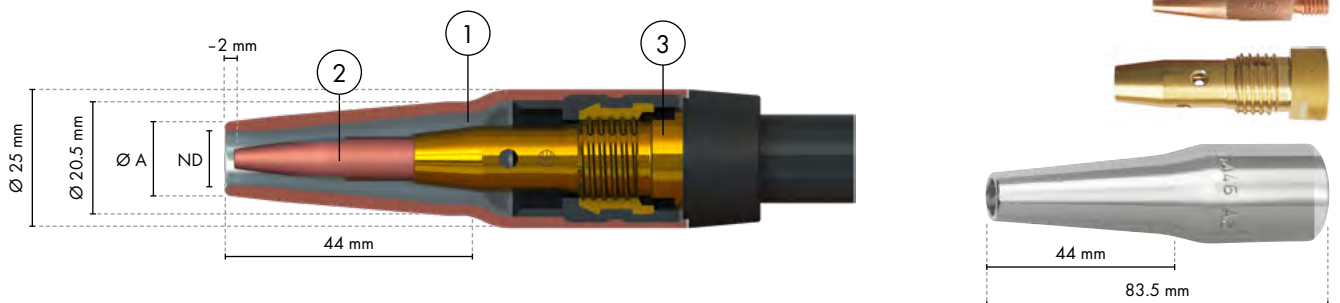

Narrow gap gas nozzle, tapered, for ABIMIG® A / A T 305 / 355 / 405

Position	Description	Length	ND	Ø A	PU (pcs.)	Part-No.
1	Gas nozzle SPI M16	83.5 mm	10.0 mm	13.2 mm	5	145.D402.5
1	Gas nozzle SPI M16	83.5 mm	8.0 mm	11.8 mm	5	145.D446.5
2	Contact tip E-Cu M6	41.0 mm	1.0 mm		10	140.D454.10
2	Contact tip E-Cu M6	41.0 mm	1.2 mm		10	140.D455.10
2	Contact tip CuCrZr M6, silver-plated	41.0 mm	1.0 mm		10	147.D010.10
2	Contact tip CuCrZr M6, silver-plated	41.0 mm	1.2 mm		10	147.D011.10
3	Contact tip holder M16/M6, with M12x1	52.0 mm	-		5	014.H231.5

ACCESSORIES & SPECIAL PARTS **ABIMIG® W/W T**

TORCH NECKS ABIMIG® W T

- ✓ **Low downtimes due to quick torch neck exchange**
- ✓ **Various geometries**
- ✓ **Rotatable 360 degrees**

The perfect fit ones: Torches must fit the welding task. Thanks to a uniform basic welding torch package for all compatible torch necks in various performance classes and geometries, the welding torches can be adapted quickly and easily to the welding task. This reduces downtimes and storage.

Variants

- Various geometries and performance classes available
- Easy, quick torch neck exchange
- Same basic torch for all performance classes
- T-interface can be rotated steplessly through 360 degrees
- Exchangeable neck model with contact tip holder, but without neck liner, gas nozzles and contact tip

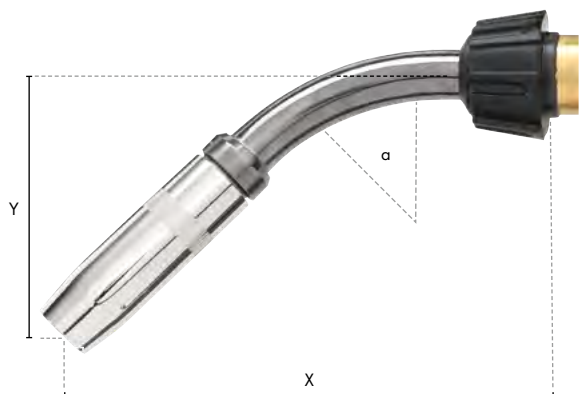

Torch necks ABIMIG® W T 340

Type	α (angle)	X	Y	Part-No. COMBI neck*	Part-No. Torch neck (not equipped)
WT 340 short	50°	125 mm	75 mm	788.0056.1	788.0057.1
WT 340 standard	50°	140 mm	85 mm	788.0019.1	788.0020.1
WT 340 straight	0°	170 mm	-	788.0127.1	788.0128.1

*COMBI neck W T 340 each equipped with a neck liner and gas nozzle 340 ND12.5 and contact tip CuCrZr M6/1.0

Torch necks ABIMIG® W T 440

Type	α (angle)	X	Y	Part-No. COMBI neck*	Part-No. Torch neck (not equipped)
WT 440 short	50°	125 mm	80 mm	788.0058.1	788.0059.1
WT 440 standard	50°	145 mm	85 mm	788.0004.1	788.0005.1
WT 440 60°	60°	165 mm	105 mm	788.0073.1	788.0074.1
WT 440 L	50°	185 mm	85 mm	788.0067.1	788.0068.1
WT 440 XL	50°	250 mm	85 mm	788.0259.1	788.0260.1
WT 440 XL	50°	350 mm	85 mm	788.0075.1	788.0076.1
WT 440 XXL	50°	500 mm	85 mm	788.0189.1	788.0171.1
WT 440 XXXL	50°	750 mm	85 mm	788.0321.1	788.0322.1
WT 440 straight	0°	175 mm	-	788.0129.1	788.0130.1

*COMBI neck W T 440 each equipped with a neck liner and gas nozzle 440 ND14.5 and contact tip CuCrZr M8/1.2

Torch necks ABIMIG® W T 540

Type	α (angle)	X	Y	Part-No. COMBI neck*	Part-No. Torch neck (not equipped)
WT 540 short	50°	140 mm	85 mm	788.0081.1	788.0082.1
WT 540 standard	50°	150 mm	90 mm	788.0025.1	788.0026.1
WT 540 L	50°	200 mm	90 mm	788.0087.1	788.0088.1
WT 540 XL	50°	360 mm	90 mm	788.0095.1	788.0096.1
WT 540 XXL	50°	495 mm	90 mm	788.0101.1	788.0102.1
WT 540 straight	0°	190 mm	-	788.0133.1	788.0134.1

*COMBI neck W T 540 each equipped with a neck liner and gas nozzle 540 ND16 and contact tip CuCrZr M8/1.2

SPECIAL TORCH NECK ABIMIG® W T 300

- ✓ **Extra short torch head**
- ✓ **Ideal for confined welding situations**
- ✓ **Different versions available**

The compact ones: When installation space is limited or the welding position is difficult to reach, it is time for the extra compact special torch necks. These have an extra-short torch head and are available with different geometries and flexible designs.

Technical data ABIMIG® W T 300

Rating:	300 A CO ₂
	300 A Mixed gas M21*
Duty cycle:	100%
Wire Ø:	1.0-1.2 mm

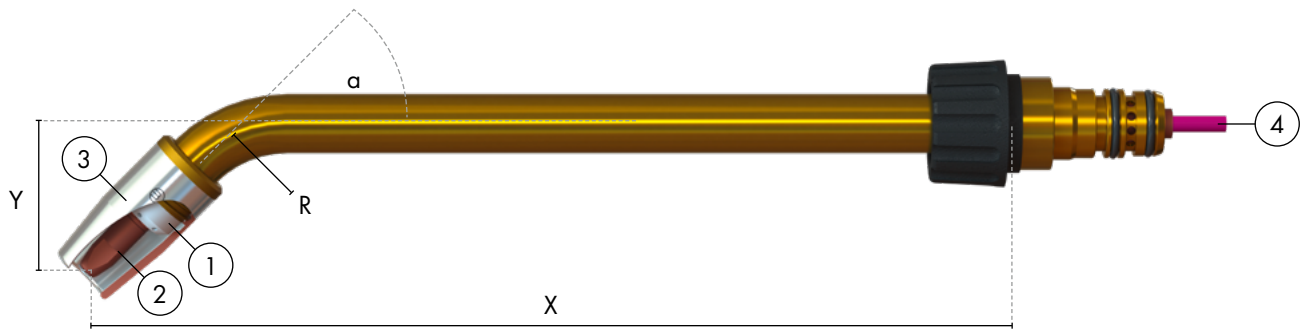

Torch necks ABIMIG® 300 W T

Description	X [mm]	Y [mm]	R [mm]	α	Part-No.
Torch neck ABIMIG® 300 W T, equipped	146	41	35	45°	022.D102.1
Torch neck ABIMIG® 300 W T, equipped	205	41	35	45°	022.D011
Torch neck ABIMIG® 300 W T, equipped	250	41	35	45°	022.D021
Torch neck ABIMIG® 300 W T, equipped	350	41	35	45°	022.D031
Torch neck ABIMIG® 300 W T, equipped	500	41	35	45°	022.D041
Torch neck ABIMIG® 300 W T, equipped	650	41	35	45°	022.D051

Equipment torch necks ABIMIG® 300 W T

Pos.	Description	Details	Part-No.
1	Gas diffuser	for ABIMIG® 300 W T / ABIMIG® 300 W	146.0076**
2	Contact tip, M6, Ø 1.2 mm, CuCrZr	for ABIMIG® 300 W T / ABIMIG® 300 W	140.0382
2	Contact tip, M6, Ø 1.0 mm, CuCrZr	for ABIMIG® 300 W T / ABIMIG® 300 W	140.0245**
2	Contact tip, M6, Ø 0.8 mm, CuCrZr	for ABIMIG® 300 W T / ABIMIG® 300 W	140.0054
3	Gas nozzle, M20x40, ND 13.5	for ABIMIG® 300 W T / ABIMIG® 300 W	145.D355**
4	Neck liner pink, L=280 mm	for ABIMIG® 300 W T, X=146/205 mm	123.D097
4	Neck liner pink, L=420 mm	for ABIMIG® 300 W T, X=250/350 mm	123.D124
4	Neck liner pink, L=720 mm	for ABIMIG® 300 W T, X=500/650 mm	123.D125

** Included in standard equipment

TORCH NECK LINER ABIMIG® W T



Torch neck liner

Type	Wire diameter	Standard length (torch neck x < 250 mm)	Special length (torch neck x = 250-650 mm)
Standard, stainless steel spiral BSL	0.8-1.2 mm	123.D097	123.D125
	1.4-1.6 mm	123.D098	123.0023.1
BPL liner plastic for aluminum (optionally stainless steel)	0.8-1.2 mm	149.0418.1	149.0418.1
	1.4-1.6 mm	149.0420.1	149.0421.1

Technical data according to EN 60 974-7 • DIN EN ISO 14175

ACCESSORIES & SPECIAL PARTS **ABIMIG® W/W T**

NARROW GAP GAS NOZZLES ABIMIG® W/W T

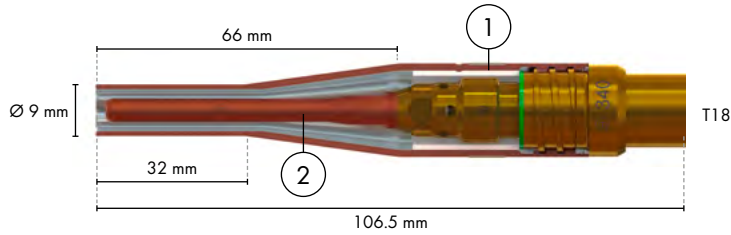

Narrow gap gas nozzle for ABIMIG® W/W T 340

Position	Description	PU (pcs.)	Part-No.
1	Gas nozzle BOT T18 ND9 L106.5	5	145.0817.5
2	Contact tip CuCrZr M6/0.8/71	10	140.1644.10
2	Contact tip CuCrZr M6/1.0/71	10	140.D465.10
2	Contact tip CuCrZr M6/1.2/71	10	140.D466.10

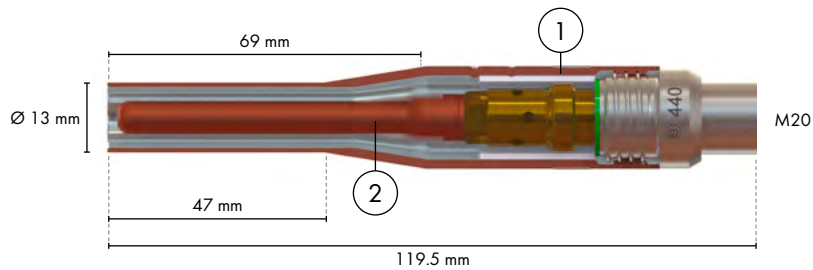

Narrow gap gas nozzle for ABIMIG® W/W T 440

Position	Description	PU (pcs.)	Part-No.
1	Gas nozzle BOT M20 ND13 L119.5	5	145.0819.5
2	Contact tip CuCrZr M8/1.0/85	10	140.1584.10
2	Contact tip CuCrZr M8/1.2/85	10	140.1585.10

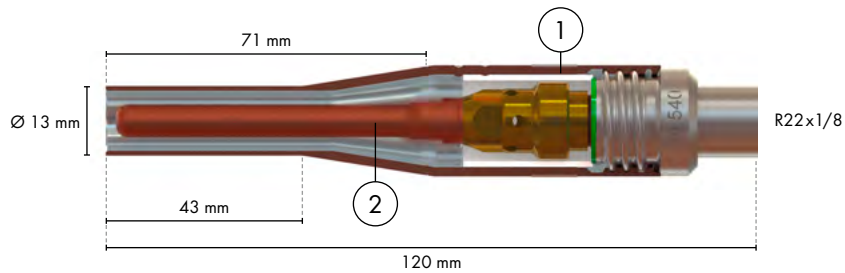

Narrow gap gas nozzle for ABIMIG® W/W T 540

Position	Description	PU (pcs.)	Part-No.
1	Gas nozzle BOT R22x1/8 ND13 L120	5	145.0821.5
2	Contact tip CuCrZr M8/1.0/85	10	140.1584.10
2	Contact tip CuCrZr M8/1.2/85	10	140.1585.10

HEAVY DUTY GAS NOZZLE ABIMIG® W / W T 540

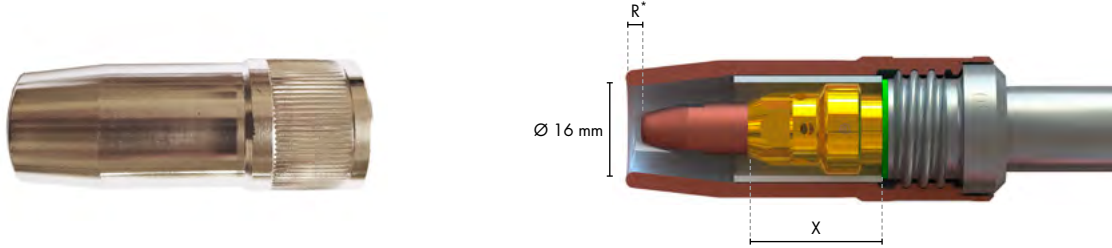

Heavy duty gas nozzle ABIMIG® W / W T 540

Type	PU (pcs.)	Part-No.
HD gas nozzle ABIMIG® W / W T 540 ND16	5	145.0857.5

*Contact tip recess R = -0.5 mm with contact tip holder x = 27 mm (142.0240.5 or 142.0248.5)

*Contact tip recess R = -2.5 mm with contact tip holder x = 25 mm (142.0239.5 or 142.0247.5)

ACCESSORIES & SPECIAL PARTS **MB**

SPECIAL TORCH NECKS MB EVO PRO 401 D/501 D

- ✓ **Fixed torch necks**
- ✓ **Special geometry for special requirements**
- ✓ **For MB EVO PRO 401 D/501 D**

The specialists: The special torch necks MB EVO PRO 401 D/501 D are available in various designs, lengths and geometries. They are designed especially for specific requirements.

Variants

- Straight and curved neck
- Lengths from 150 to 650 mm
- Individual special variants available on request

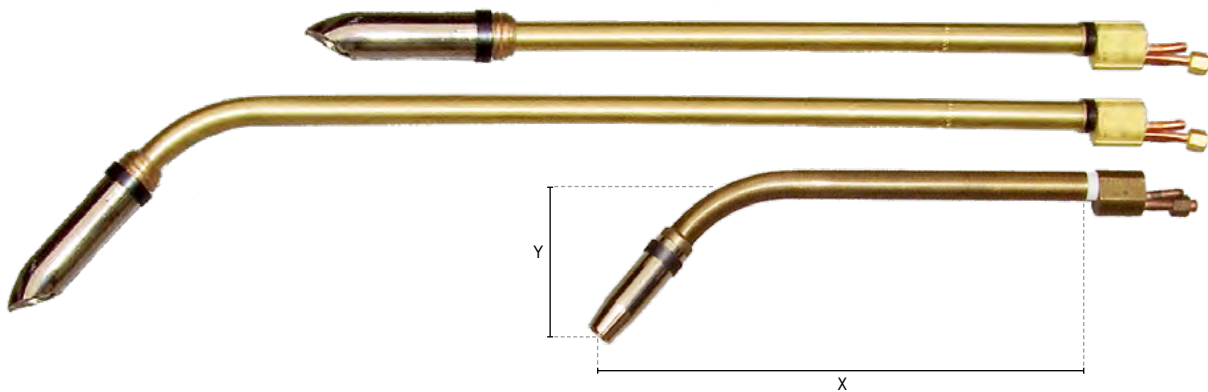

Special torch necks MB EVO PRO 401 D/501 D				
Description	Angle	X	Y	Part-No.
standard MB EVO PRO 401 D	50°	110	95	033.0378.1
standard MB EVO PRO 501 D	50°	150	95	034.0856.1
for wires that are difficult to feed	30°	175	54	034.1079.1
long (+100 mm)	50°	250	95	034.0929.1
long (+150 mm)	50°	300	95	034.0930.1
long (+350 mm)	50°	500	95	034.0932.1
long (+650 mm)	50°	800	95	034.1005.1
straight neck standard	0°	190	0	034.1029.1
straight neck long (+310 mm)	0°	500	0	034.1085.1

Further geometries available on request

NARROW GAP GAS NOZZLES MB

- ✓ **Coated narrow gap nozzle**
- ✓ **Narrow gap nozzle with exchangeable gas nozzle extension**
- ✓ **Ideal for working in joints and gaps**

The slim ones: The narrow gap nozzles for different welding torch types are available with coating or with exchangeable gas nozzle extension. Because of the narrow gap between contact tip and gas nozzle, a regular check for adhering welding spatters and dirt is required. In addition it is recommended to use ABICOR BINZEL ceramic spray.

Technical data

Rating: 250 A CO₂
 Duty cycle: 60%
 Wire Ø: 1.0–1.2 mm

- Reduced spatter adhesion due to coating
- Cost-effective adaptation due to a exchangeable gas nozzle extension
- For torches MB 401/501, MB 26, MB 36 and ABIMIG® GRIP W 555

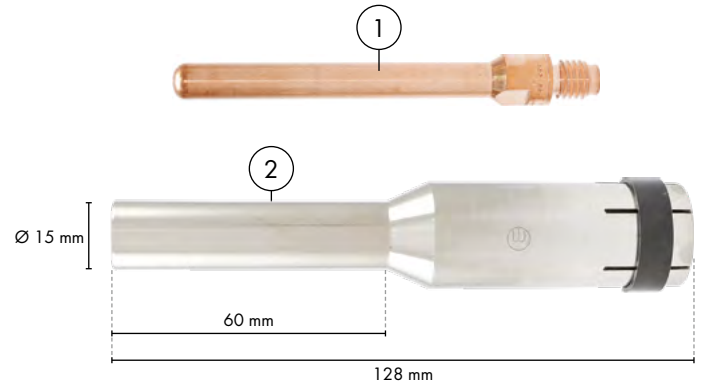

Gas nozzles and narrow gap gas nozzles for MB			
Position	Description	PU (pcs.)	Part-No.
1	Contact tip 1.0 CuCrZr M8/1.0/85	10	140.1584.10
1	Contact tip 1.2 CuCrZr M8/1.2/85	10	140.1585.10
2	Gas nozzle ND12, AD15, L128	5	145.0707.5

For MB 36 use the contact tip holder 142.0082 and gas diffuser 018.0260.10.

Narrow gap gas nozzle with exchangeable gas nozzle extension for torch types MB 401/501; MB26; MB 36 and ABIMIG® GRIP W 555.

Due to the narrow gap between the contact tip and gas nozzle, regular checks for adhering weld spatter and dirt are necessary. We recommend using the ABICOR BINZEL Ceramic Spray 192.0228.1 to reduce the adhesion of weld spatter and make cleaning the parts easier.

Technical data

Rating: 250 A CO₂
 Duty cycle: 60%
 Wire Ø: 1.0–1.2 mm

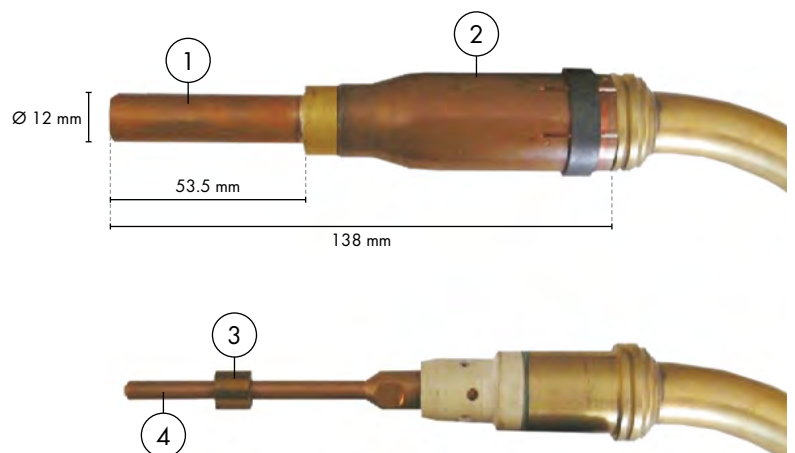

Narrow gap gas nozzles for MB			
Position	Description	PU (pcs.)	Part-No.
1	Extension for gas nozzle Di10/Da12	10	030.0010
2	Gas nozzle base body	10	145.0166
3	Centering piece	10	030.0118
4	Contact tip E-Cu M8/1.0/95	10	140.0343
4	Contact tip E-Cu M8/1.2/95	10	140.0475

For MB 36 use the contact tip holder 142.0082 and gas diffuser 018.0260.10.

ACCESSORIES & SPECIAL PARTS **MB**

NARROW GAP SYSTEM MB HD PRO

- ✓ **Ideal for working in joints and gaps**
- ✓ **Long service life**
- ✓ **Improved view**

The system solution: For particularly narrow applications, the MIG/MAG narrow gap systems HD PRO with push-on gas nozzle are a good and durable choice. They enable welding in narrow gaps and ensure exceptionally average service lives.

Advantages at a glance

- Improved view of weld seam due to slim design
- Increased service life thanks to material combination and coating
- No short circuits on narrow components due to perfect electrical insulation
- Two standard variants: joint depth 90 and 150 mm
- Variants for two wire diameters: 1.0 and 1.2 mm

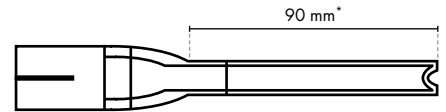
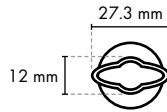
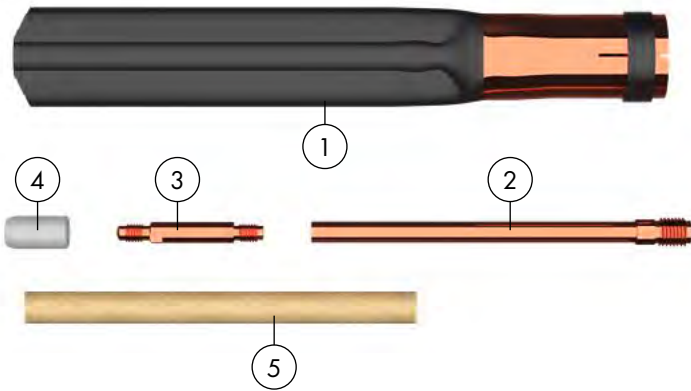
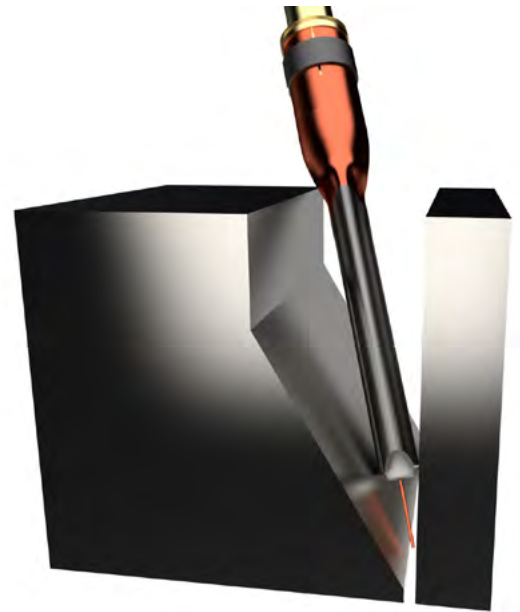

*In 90 mm and 150 mm available

Narrow gap system HD PRO			
Position	Description	PU (pcs.)	Part-No.
1-5	Narrow gap system HD PRO 90/1.0	1	528.0030.1
1-5	Narrow gap system HD PRO 90/1.2	1	528.0001.1
1-5	Narrow gap system HD PRO 150/1.0	1	528.0031.1
1-5	Narrow gap system HD PRO 150/1.2	1	528.0005.1
1	Gas nozzle HD PRO 90	1	528.0023.1
1	Gas nozzle HD PRO 150	1	528.0022.1
2	Current contact tube 90	1	528.0003.1
2	Current contact tube 150	1	528.0007.1
3	Contact tip HDS/M5/1.0/40	5	528.0009.5
3	Contact tip HDS/M5/1.2/40	5	528.0010.5
4	Insulating cap	1	528.0011.1
5	Insulating tube 90	1	528.0004.1
5	Insulating tube 150	1	528.0008.1

Contact tip holder			
Torch type	Description	PU (pcs.)	Part-No.
MB 401 / 501	Contact tip holder M8 / M10x1 · 25.0 mm	10	142.0022
MB 36	Contact tip holder M8 / M 8 · 22.0 mm	10	142.0082
ABIMIG® GRIP W 555	Contact tip holder M8 / M10x1 · 25.0 mm	10	142.0022

The HD PRO narrow gap system can be used with the torch types mentioned in use with the contact tip holders listed. Please note that the nozzle assembly may differ from the variants installed in series.

BENT GAS NOZZLES FOR MB WELDING TORCHES

■ Bent gas nozzles and contact tips for hard-to-reach welding seams in narrow working spaces

■ For welding torch types MB 24, MB 240, MB 26, MB 36, MB 401/501 and ABIMIG® GRIP W 555

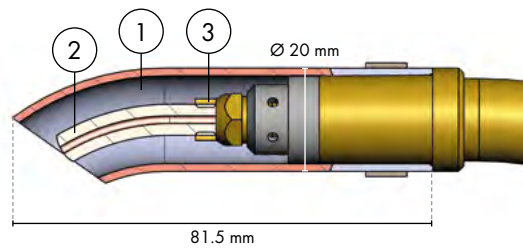
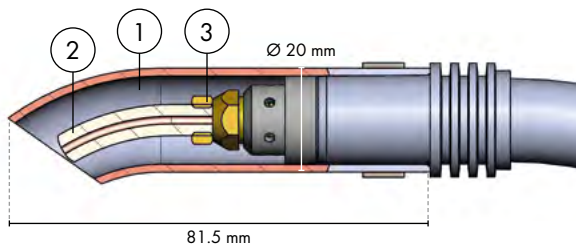
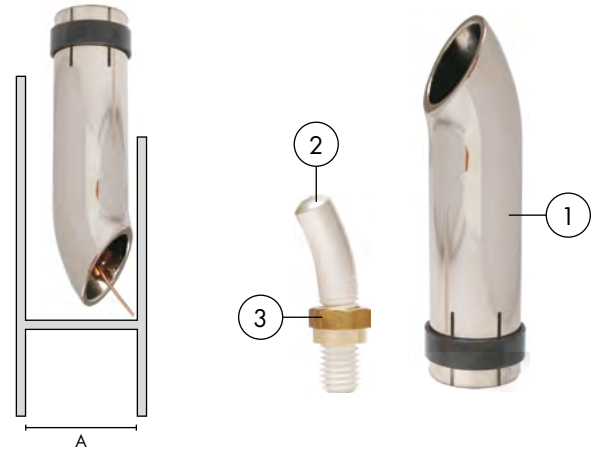

Bent gas nozzles for MB 240 D and MB 24 KD

Position	Description	A	Wire Ø	PU (pcs.)	Part-No.
1	Gas nozzle bent Da20 Di17 L82	25 mm	-	5	145.D457.5
2	Contact tip E-Cu M6/0.8 bent	-	0.8 mm	10	140.1666.10
2	Contact tip E-Cu M6/1.0 bent	-	1.0 mm	10	140.D476.10
2	Contact tip E-Cu M6/1.2 bent	-	1.2 mm	10	140.D478.10
3	Hex nut M6 SW8	-	-	10	001.D220.10

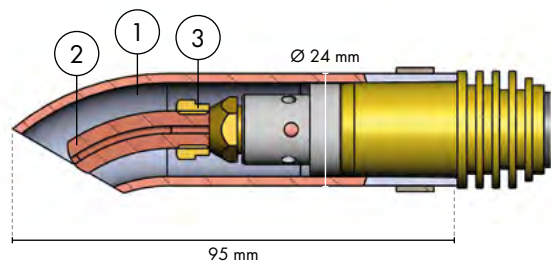
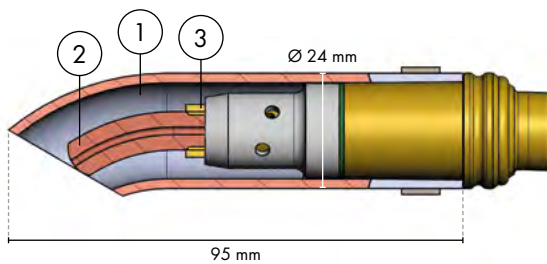

Bent gas nozzles for MB 26, MB 36, MB 401/501 and ABIMIG® GRIP W 555*

Position	Description	A	Wire Ø	PU (pcs.)	Part-No.
1	Gas nozzle bent Da24 Di20 L95	30 mm	-	5	145.D460.5
2	Contact tip CuCrZr M8/1.0/41 bent, silver-plated	-	1.0 mm	10	147.D481.10
2	Contact tip CuCrZr M8/1.2/41 bent, silver-plated	-	1.2 mm	10	147.D482.10
3	Hex nut M8 SW11	-	-	10	001.D221.10

*For MB 36 use the contact tip holder 142.0082 and gas diffuser 018.0260.10.

For MB 401 D/501 D and ABIMIG® GRIP W 555 use contact tip holder 142.0022.

ACCESSORIES & SPECIAL PARTS **MB**

LIQUID COOLED GAS NOZZLE ■ MB 401/501 ABIMIG® GRIP W 555

- ✓ **Liquid cooled special gas nozzle**
- ✓ **For high-amperage welding with high duty cycle on preheated components**
- ✓ **For all MB 401/501 welding torch series and ABIMIG® GRIP W 555**

The cooled ones: The liquid cooled special gas nozzles for MIG/MAG welding torches are developed especially for the most demanding welding tasks. They are suitable for applications where the heat released by the welding arc and weld metal exceeds the application ranges of conventional gas nozzles. The gas nozzles must be connected to an auxiliary cooling system or connected in series with the cooling system of the welding torch.



Liquid cooled gas nozzle MB 401/501 and ABIMIG® GRIP W 555		
Description	PU (pcs.)	Part-No.
Gas nozzle cyl. ND16 L76, liquid cooled	1	145.0064

NICKLE-PLATED GAS NOZZLES ■ MB 401/501 ■ ABIMIG® GRIP W 555

- **Nickle-plated surface for less spatter adhesion and reflected radiant heat**
- **For all MB 401/501 welding torch series and ABIMIG® GRIP W 555**

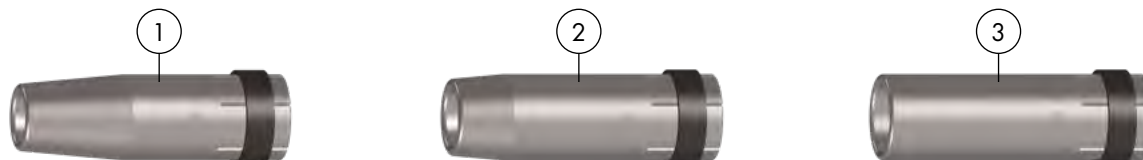

Gas nozzle nickle-plated MB 401/501 and ABIMIG® GRIP W 555			
Position	Description	PU (pcs.)	Part-No.
1	Gas nozzle conical ND14 76 mm	10	145.D387.10
2	Gas nozzle conical ND16 76 mm	10	145.D388.10
3	Gas nozzle cylindrical ND20 76 mm	10	145.D389.10

HEAVY DUTY GAS NOZZLES ■ MB 25 / 24 / 240 / 401 / 501 ABIMIG® GRIP W 555

The heat-resistant ones: With their thicker walls, heavy duty gas nozzles are ideal for welding applications where great heat is generated. For example, during welding in the high amperage range or with preheated components.

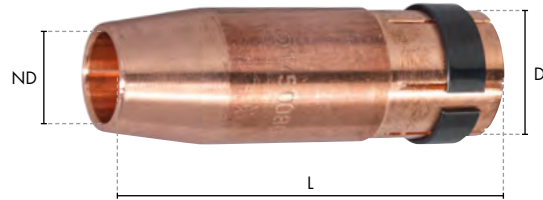

Heavy duty gas nozzles for MB 25 / 24 / 240 / 401 / 501 and ABIMIG® GRIP W 555						
Torch type	Description	ND	D	L	PU (pcs.)	Part-No.
MB25	Pressed insulation, conical, nickel-plated surface	15	25	57	10	145.D030
MB 24 / MB 240	Conical, nickel-plated surface	12.5	21	63.5	10	145.0101
MB 24 / MB 240	Cylindrical, nickel-plated surface	17	21	63.5	10	145.0062
MB 401 / 501 ABIMIG® GRIP W 555	Only use with spatter protection 146.0013	16	25	76	10	145.0086

SPOT GAS NOZZLES FOR MB WELDING TORCHES

The spacers: Spot gas nozzles are used for spot welding of sheet metal and tacking components. They are placed on the workpiece to ensure a constant distance. This makes the work easier and ensures consistent quality.



Spot gas nozzles for MB welding torches					
Torch type	ND	D	L	PU (pcs.)	Part-No.
MB15	16	19	60	10	145.0168.10
MB 25	18	22	67	10	145.0169.10
MB 24 / MB 240	17	20	68	10	145.0174.10
MB 36	20	24	90	10	145.0172.10
MB 26 / MB 401 / 501 ■ ABIMIG® GRIP W 555	20	24	85	10	145.0179.10

BIKOX® CABLES ■ CONTROL CABLES ■ HOSES

CABLES, HOSES AND CONTROL CABLES FOR THE SERVICE AND REPAIR OF MIG/MAG WELDING TORCHES

Cable assemblies gas cooled		Cable assembly length			
Type	BIKOX®	3 m	4 m	5 m	8 m
MB EVO PRO 15 / ABIMIG® 155 LW	R4 / LW	160.H025.1	160.H026.1	160.H027.1	-
MB EVO PRO 24	R6-5 / LW	160.1330.1	160.1331.1	160.1332.1	-
MB EVO PRO 25 / ABIMIG® 255 LW	R5 / LW	160.H032.1	160.H033.1	160.H034.1	-
MB EVO PRO 26 / ABIMIG® 305 LW	R6 / LW	160.H039.1	160.H040.1	160.H041.1	-
MB EVO PRO 36 / ABIMIG® 355 LW	R7 / LW	160.H046.1	160.H047.1	160.H048.1	-
MB EVO 15	R10	160.1291.1	160.1292.1	160.1293.1	-
MB EVO 24	R25	160.D427	160.D428	160.D429	-
MB EVO 25	R20	160.1294.1	160.1295.1	160.1296.1	-
MB EVO 26	R30	160.1305.1	160.1306.1	160.1307.1	-
MB EVO 36	R30	160.1308.1	160.1309.1	160.1310.1	-
Push-Pull Plus 36 D	Type 35	-	-	-	118.0074

Cable assemblies liquid cooled		Cable assembly length				
Type	Description	3 m	4 m	5 m	8 m	per m
MB EVO PRO 240 / 401 / 501	Power cable FRH	115.0830.1	115.0831.1	115.0832.1	-	-
MB EVO 240 / 401 / 501	Power cable PVC	115.0833.1	115.0834.1	115.0835.1	-	-
ABIMIG® GRIP W 555	Power cable PVC	115.0581	115.0582	115.0583	-	-
ABIMIG® W 340 / 440 / 540	Power cable PVC	115.0855.1	115.0856.1	115.0857.1	-	-
Push-Pull Plus 401	Power cable PVC	-	-	-	115.0043	-
MB EVO PRO 240 / 401 / 501	Wire conduit / gas hose	154.0017.1	154.0018.1	154.0019.1	-	-
ABIMIG® GRIP W 555	Wire conduit	156.0275	156.0276	156.0277	-	-
ABIMIG® W T 340 / 440 / 540	Wire conduit / gas hose	109.0094.1	109.0095.1	109.0096.1	-	-
ABIMIG® W 340 / 440 / 540	Wire conduit / gas hose	154.0020.1	154.0021.1	154.0022.1	-	-
Push-Pull Plus 401	Wire conduit	-	-	-	156.0273	-
MB EVO PRO 240 / 401 / 501	Water hose black FRH - Ø 5.5x1.5	-	-	-	-	109.0052
MB GRIP 240 / 401 / 501						
MB EVO 240 / 401 / 501	Water hose red PVC - Ø 5.5x1.5	-	-	-	-	109.0056
ABIMIG® W T 340 / 440 / 540						
ABIMIG® W 340 / 440 / 540						
Push-Pull Plus 401						
MB EVO 240 / 401 / 501	Water hose blue PVC - Ø 5.5x1.5	-	-	-	-	109.0057
ABIMIG® GRIP W 555						
ABIMIG® W 340 / 440 / 540						
ABIMIG® W T 340 / 440 / 540						
Push-Pull Plus 401						

Cable assemblies liquid cooled		Cable assembly length				
Type	Description	3 m	4 m	5 m	8 m	per m
ABIMIG® GRIP W 555	Gas hose	-	-	-	-	109.0040
Push-Pull Plus 401	Gas hose	-	-	-	-	109.0040
all torches	Control cable 2-pole	-	-	-	-	100.0019

Outer hose		Cable assembly length			
Type	Description	3 m	4 m	5 m	per m
MB EVO PRO 240 / 401 / 501	Outer hose 25x1.5 (with bend protection)	107.0109.1	107.0110.1	107.0111.1	107.0004
MB EVO 240 / 401 / 501 ABIMIG® 340 / 440 / 540	Outer hose 25x1.5 (with bend protection)	107.0109.1	107.0110.1	107.0111.1	107.0004
ABIMIG® GRIP W 555	Outer hose 25x1.5	-	-	-	107.0004
Push-Pull Plus 36 / 401	Outer hose 25x1.5	-	-	-	107.0004
ABIMIG® W T 340 / 440 / 540	Outer hose 25x1.5 (with bend protection)	107.0079	107.0044	107.0080	-

Hose clamps ▪ Quick connector ▪ Marking washer			for hose			
Type	PU (pcs.)	Part-No.	109.0040	109.0052	109.0056	109.0057
Hose clamp D=9.5 stepless MB EVO PRO / MB EVO	20	173.0015.20	-	•	•	•
Hose clamp Ø=8.7	100	171.0002	•	-	-	-
Hose clamp Ø=9.0 with ring (mark. 9.5)	100	173.0001	-	-	•	•
Hose clamp Ø=9.5 with ring (mark. 10.0)	100	173.0002	-	•	-	-
Hose clamp Ø=9.5	20	173.0015.20	-	-	-	•
Quick connector ND 5 / Ø=6.0	20	501.0114	-	•	•	•
Marking washer red	20	501.2166	-	•	-	-
Marking washer blue	20	501.2167	-	•	-	-
Fastener cap red	20	501.2423	-	•	•	-
Fastener cap blue	20	501.2424	-	•	-	•

HANDLES ■ MODULES

HANDLES, TRIGGERS AND REMOTE CONTROL MODULES FOR REPAIR OR CONVERSION OF THE WELDING TORCHES

Handle MB EVO PRO without modules



Type	Description	Part-No.
Handle type MB EVO PRO gas cooled, standard, without modules	for MB EVO PRO 15 / 24 / 25 / 26 / 36	180.0176.1
Handle type MB EVO PRO liquid cooled, standard, without modules	for MB EVO PRO 240 / 401 / 501	180.0177.1
Cable protection MB EVO PRO	for MB EVO PRO 15 / 24 / 25 / 26 / 36	400.D574.1
Half rings red	for ball joint cable protection (400.D574.1)	400.D561.2

Handle MB EVO PRO for modules



Please contact us for the exact configuration of module torches.

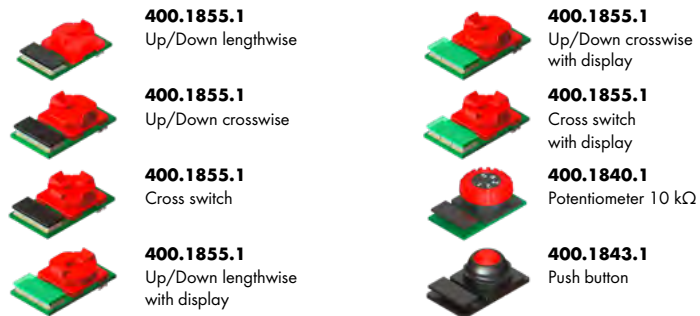

Type	Description	Part-No.
Handle type MB EVO PRO gas cooled, for modules	for MB EVO PRO 24 / 36	180.0192.1
Handle type MB EVO PRO liquid cooled, for modules	for MB EVO PRO 240 / 401 / 501	180.0193.1
Control module set	U/D lengthwise and crosswise, cross switch, with and without display	400.1855.1
Control module	potentiometer 10 kΩ	400.1840.1
Control module	push button	400.1843.1
Cable protection MB EVO PRO	for MB EVO PRO 15 / 24 / 25 / 26 / 36	400.D574.1
Half rings red	for ball joint cable protection (400.D574.1)	400.D561.2

Handle MB EVO without modules



Type	Description	Part-No.
Handle type MB EVO gas cooled	for MB EVO 15 / 24 / 25 / 26 / 36	180.0178.1
Handle type MB EVO liquid cooled	for MB EVO 240 / 401 / 501	180.0179.1
Cable protection MB EVO	for MB EVO 15 / 24 / 25 / 26 / 36	400.D574.1
Half rings black	for ball joint cable protection (400.D574.1)	400.D451.2

Handle ABIMIG® GRIP S without modules



Type	Description	Part-No.
Handle type ABIMIG® GRIP S	for ABIMIG® GRIP W 555	180.0132.1
Ball joint cable protection ABIMIG® GRIP W liquid cooled	for ABIMIG® GRIP W 555	400.1392.1
Innening ABIMIG® GRIP W liquid cooled	for ball joint cable protection (400.1392.1)	400.0790

Handle ABIMIG® GRIP SH for modules



incl. add-on for control modules
Part-No.:180.0133.1



BIS-01L



BIS-01R



BIS-02



BIS-06



BIS-07B



BIS-10B



BIS-10D



BIS-13A



BIS-18



BIS-19

incl. add-on for control modules

Type	Description	Part-No.
Handle Typ ABIMIG® GRIP SH (without control module)	for MB GRIP 15/24/25/26/36/240/401/501 to use only with adapter 400.1341.1	180.0133.1
Handle Typ ABIMIG® GRIP SH (without control module)	for ABIMIG® GRIP W 555	
BIS-01L	control module with potentiometer left 10 kΩ	400.0956
BIS-01R	control module with potentiometer right 10 kΩ	400.0957
BIS-02	control module with potentiometer left 10 kΩ LED for Migatronik*	400.0958
BIS-06	control module with trigger 4 LED	400.0959
BIS-07B	control module Up/Down 7-segment switch crosswise	400.0961
BIS-10B	control module Up/Down switch crosswise	400.0964
BIS-10D	control module Up/Down switch crosswise for Fronius*	400.1085
BIS-13A	control module Up/Down 2x switch lengthwise for EWM*	400.0966
BIS-18	control module Up/Down 2x Taster for Cloos*	400.1545.1

*Compatible for use with products from the companies mentioned. All rights of the trademark owners reserved.

HANDLES ■ MODULES

Handles ABIMIG® A T / W T without modules



Assembly group with blind cover and trigger



Up/Down module

Type	Description	Part-No.
Handle ABIMIG® A T	for ABIMIG® A T LW 155 / 255 / 305 / 355 / 405	180.D077.1
Joint protection ABIMIG® A T, short	for ABIMIG® A T LW 155 / 255 / 305 / 355 / 405	400.D574.1
Handle ABIMIG® W T	for ABIMIG® W T 340 / 440 / 540	180.0164.1
Half rings (fixes cable protection on handle), 1 pair	for ABIMIG® A T LW 155 / 255 / 305 / 355 / 405 / ABIMIG® W T 340 / 440 / 540	400.D561.2
Up/Down module	for ABIMIG® A T LW 155 / 255 / 305 / 355 / 405 / ABIMIG® W T 340 / 440 / 540	400.1291.1
TPE inlet for Up/Down module	for ABIMIG® A T LW 155 / 255 / 305 / 355 / 405 / ABIMIG® W T 340 / 440 / 540	400.1634.2

Handle ABIMIG® A T S



Type	Description	Part-No.
Handle ABIMIG® A T S	for ABIMIG® A T S LW 155 / 255 / 355	180.0208.1

Handles ABIMIG® A/W without modules



Assembly group with blind cover and trigger



Up/Down module

Type	Description	Part-No.
Handle ABIMIG® A/W	for ABIMIG® A LW 155 / 255 / 305 / 355 / 405	180.0180.1
Joint protection ABIMIG® A, short	for ABIMIG® A LW 155 / 255 / 305 / 355 / 405	400.D574.1
Handle ABIMIG® W	for ABIMIG® W 340 / 440 / 540	180.0180.1
Half rings (fixes cable protection on handle), 1 pair	for ABIMIG® A LW 155 / 255 / 305 / 355 / 405 / ABIMIG® W 340 / 440 / 540	400.D561.2
Up/Down module	for ABIMIG® A T LW 155 / 255 / 305 / 355 / 405 / ABIMIG® W T 340 / 440 / 540	400.1291.1
TPE inlet for Up/Down module	for ABIMIG® A T LW 155 / 255 / 305 / 355 / 405 / ABIMIG® W T 340 / 440 / 540	400.1634.2

Handle ABIMIG® A/W for modules



Please contact us for the exact configuration of module torches.



400.1855.1
Up/Down lengthwise

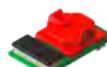

400.1855.1
Up/Down crosswise



400.1855.1
Cross switch



400.1855.1
Up/Down lengthwise
with display



400.1855.1
Up/Down crosswise
with display



400.1855.1
Cross switch
with display

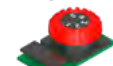

400.1840.1
Potentiometer 10 kΩ



400.1843.1
Push button

Type	Description	Part-No.
Handle Type ABIMIG® A/W for modules incl. screws, threaded bushings, long and short button	for ABIMIG® A LW 155 / 255 / 305 / 355 / 405 / and ABIMIG® W 340 / 440 / 540	180.0191.1

Trigger for handles ABIMIG® A / W / AT / WT / ATS





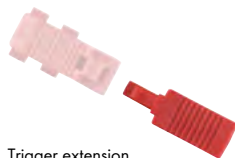

















Trigger with extension
185.0158.1



Trigger extension
185.0160.1

Type	Description	Part-No.
Trigger with extension	for handles ABIMIG® A / W / AT / WT / ATS	185.0158.1
Trigger extension	for handles ABIMIG® A / W / AT / WT / ATS	185.0160.1

CONTENTS TIG

		COOLING	RATING	FROM PAGE	
BINZEL STYLE FROM PAGE 98	ABITIG® GRIP 150/150 F ■ ABITIG® GRIP 260 W ABITIG® GRIP 260 W SC		105-340 A	100	
	ABITIG® GRIP A T 150 ■ ABITIG® GRIP W T 260 W		105-260 A	102	
	ABITIG® GRIP 200 ■ ABITIG® GRIP 450 W ABITIG® GRIP 450 W SC		140-450 A	104	
	ABITIG® GRIP A T 200 ■ ABITIG® GRIP W T 450 W		130-400 A	106	
	ABITIG® GRIP 500 W		350-500 A	108	
	ABITIG® GRIP LITTLE 90 ABITIG® GRIP LITTLE 180 W		60-180 A	110	
	ABITIG® GRIP LITTLE 150/150 F ABITIG® GRIP LITTLE 260 W / 260 W F		100-240 A	112	
	ABITIG® 150 MT ■ ABITIG® 260 W MT		110-260 A	114	
	ABITIG® 200 MT ■ ABITIG® 300 W MT ABITIG® 450 W MT		140-450 A	116	
	ABITIG® 400 W MT ■ ABITIG® 500 W MT		280-500 A	118	
	WELDING TORCHES WITH COLD WIRE FEED		140-500 A	120	
	STANDARD STYLE FROM PAGE 122	ABITIG® GRIP 9 ■ ABITIG® GRIP 20/20 SC		80-240 A	124
		ABITIG® GRIP 17 ■ ABITIG® GRIP 18 ABITIG® GRIP 26		100-320 A	126
		ABITIG® GRIP 24 G ■ ABITIG® GRIP 24 W		80-140 A	128
		ABITIG® GRIP 12-1		250-350 A	130
		ABITIG® GRIP 18 SC		280-400 A	132
		ABITIG® GRIP LITTLE 9/9 F ABITIG® GRIP LITTLE 20		80-220 A	134
		ABITIG® GRIP LITTLE 17/17 F/17 V		100-140 A	136
		ABITIG® GRIP LITTLE 24 G ABITIG® GRIP LITTLE 24 W		80-140 A	138
ABITIG® TORCHES WITH ROTARY VALVE			80-180 A	140	
TUNGSTEN ELECTRODES				142	
WIRE FEEDER SYSTEM		ABIDRIVE V2		144	
COMPONENT KITS				148	
POWER CABLES ■ CONTROL CABLES ■ HOSES			149		
HANDLES ■ MODULES			152		
ACCESSORIES AND SPECIAL PARTS	ABITIG® GRIP LITTLE 25 F ■ ABITIG® GRIP LITTLE 20 F			154	
	ABITIG® GRIP LITTLE SL 9/17/26/18/20			155	
	SHORT EQUIPMENT OPTIONS (STUBBY) FOR ABITIG® 9/20			156	
	FURTHER WEAR PARTS FOR ABITIG® 17/18/26			157	
	NARROW GAP GAS NOZZLES FOR ABITIG® 150/260 W			158	
	GAS NOZZLE ABITIG® 500 W SHORT			158	
	METAL GAS NOZZLE FOR ABITIG® 500 W MT			159	
TORCH MOUNTS ABITIG® MT 150/200/260 W/300 W/400 W/500 W			159		



TIG WELDING TORCHES **BINZEL STYLE**

INTELLIGENT HEAT DISSIPATION – SIMPLE BUT CLEVER

Perfect cooling is essential for TIG-welding

With its torch design which has been ingeniously thought out right down to the last detail, ABICOR BINZEL has managed to achieve significantly more power despite reducing the overall design size of the TIG welding torches at the same time.

Both the torch body and wearing parts were optimized for this. Always with the clear objective of improvement heat dissipation and the temperature of the individual components. Because the lower the temperature the longer the service life of both the wearing parts and the welding torch.

The advanced development of the ABICOR BINZEL concept is clearly demonstrated by the reduced

distance of the cooling to the power-transmitting and thus hot surface (A), the much larger cooling areas (B) and the optimized heat transfer (C). These factors all contribute to extending the lifetime of the wearing parts and greatly increasing the service life of the welding torch.

Furthermore, the gas cover has been significantly improved by the lower heat supply so that there is hardly any turbulence. The arc remains extremely still, the risk of pore formation is reduced considerably and the well-cooled front-end of the torch guarantees reliable and steady ignition behaviour.

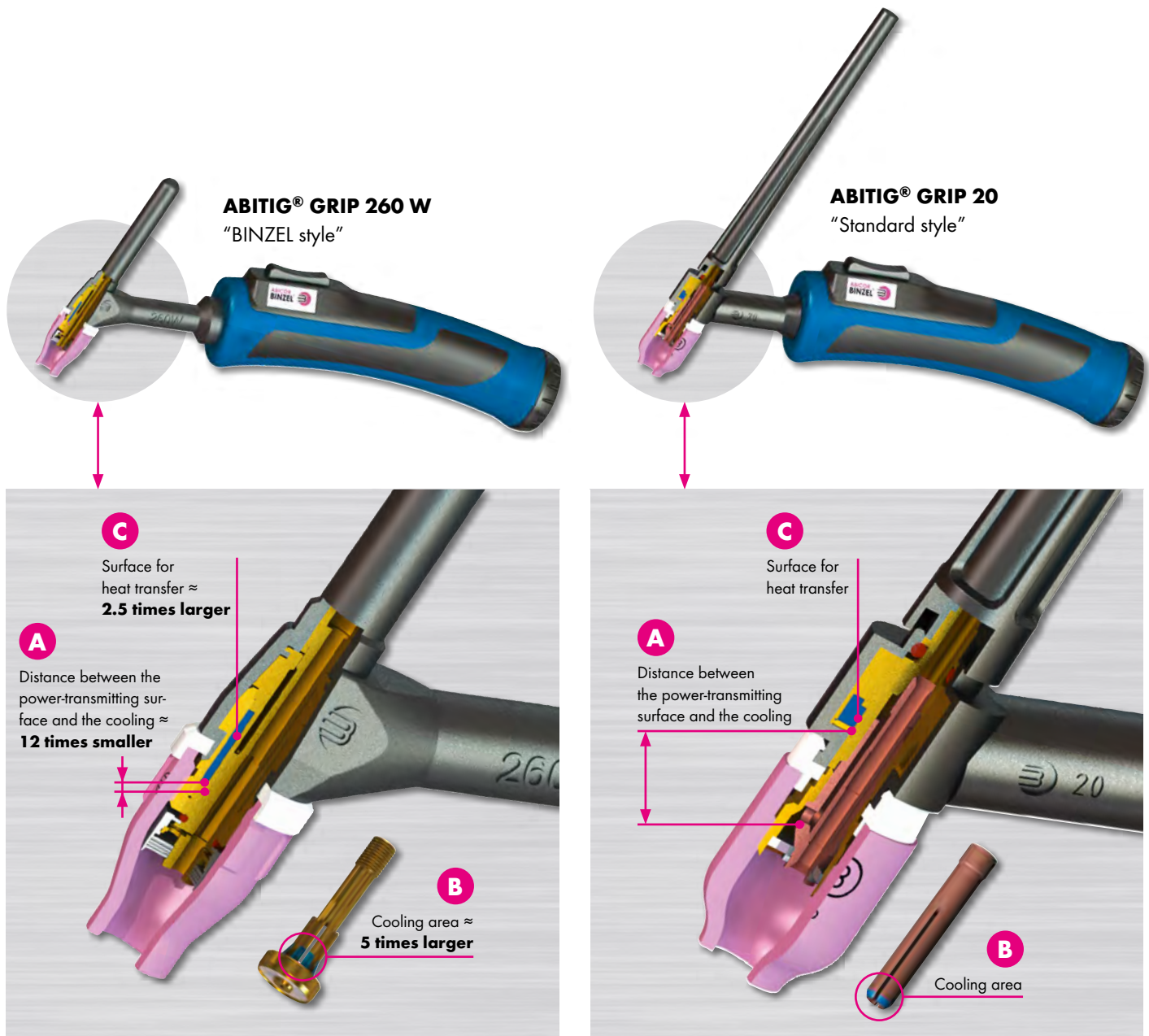

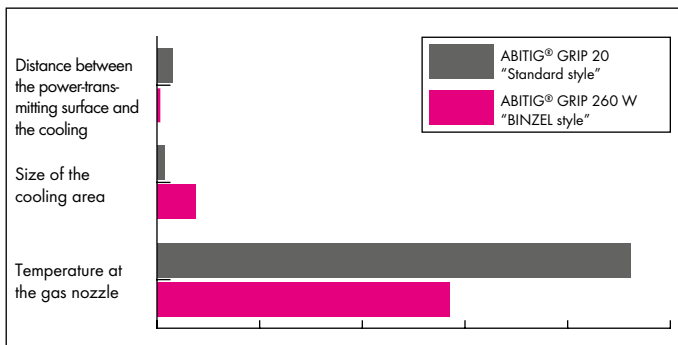

The reduced distance between the power-transmitting surface and the cooling as well as the larger cooling surfaces of the wearing parts reduce the torch temperature in the front area of the gas nozzle of the "BINZEL style" torch by up to 180°C.

A reduction in heat development of more than 35% with the same test setup and welding parameters in the front-end is impressive proof of the effectiveness of the innovative ABICOR BINZEL concept.

BINZEL STYLE WEAR PARTS: LESS IS MORE



BETTER GAS COVERAGE - BETTER WELD SEAM

The illustrations clearly show the improved laminar gas flow with the ABITIG® GRIP 260 W torch for the best gas coverage and prevention of pores compared to the "Standard style" ABITIG® GRIP 20 torch.





WELDING TORCHES BINZEL STYLE

TIG WELDING TORCHES **BINZEL** STYLE

BINZEL style:

- ✓ **Optimized cooling concept**
- ✓ **Improved gas coverage**
- ✓ **Less wear parts**

Optimized cooling concept

All BINZEL style TIG welding torches score with improved heat dissipation, which significantly increases the service life. This is achieved by reducing the distance between the cooling system and the current-transmitting and therefore hot surface, the significantly larger cooling surface and a better coolant flow. Another advantage of this torch system is the improved current transfer due to the larger surface area.

Improved gas coverage

An optimized, unique design of the torch components guarantees ideal shielding gas coverage. The gas flow is virtually turbulence-free and enables outstanding welding results.

Less wear parts

All BINZEL style TIG torches have a reduced wear parts concept. The result for you is less parts for maintenance, faster replacement and lower storage costs.

Overview of rating ABITIG® welding torches BINZEL style

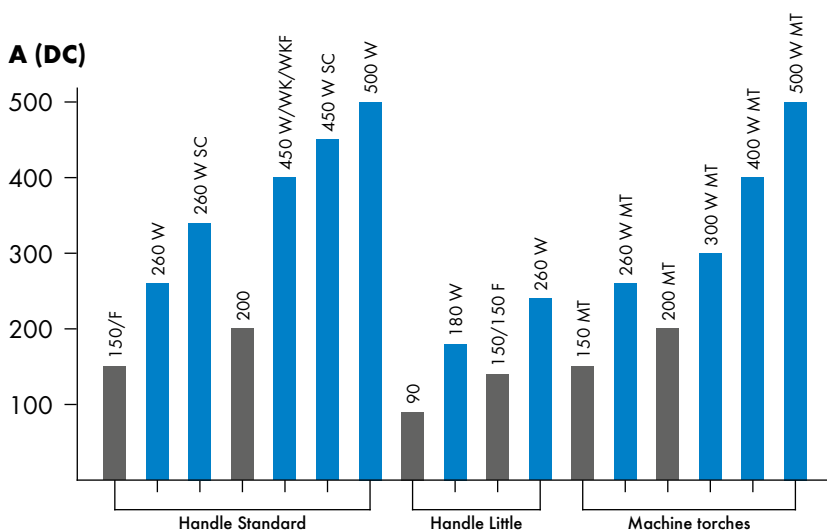

GAS COOLED LIQUID COOLED

- 2K handle with grip inlay and excellent ergonomics
- Excellent grip safety, including ultra-small handle design in the Little version
- Robust switching and control functions in the handle
- Ball joint for optimum range of movement and ideal handling
- Lightweight, flexible leather cable assemblies made from high flex leather (HFL)
- For all common TIG power sources
- Excellent HF safety



Type	Cooling	DC	AC	Duty cycle	Tungsten electrodes Ø
ABITIG® GRIP 150 / 150 F	gas cooled	150 A	105 A	35%	1.0–2.4 mm
ABITIG® GRIP 260 W	liquid cooled	240 A	185 A	100%	1.0–3.2 mm
ABITIG® GRIP 260 W SC	liquid cooled	340 A	240 A	100%	1.0–3.2 mm
ABITIG® GRIP 200	gas cooled	200 A	140 A	35%	1.6–3.2 mm
ABITIG® GRIP 450 W/WK/WKF	liquid cooled	400 A	280 A	100%	1.6–4.8 mm
ABITIG® GRIP 450 W SC	liquid cooled	450 A	320 A	100%	1.6–4.8 mm
ABITIG® GRIP 500 W	liquid cooled	500 A	350 A	100%	1.6–6.4 mm
ABITIG® GRIP Little 90	gas cooled	90 A	60 A	35%	1.0–1.6 mm
ABITIG® GRIP Little 180 W	liquid cooled	180 A	130 A	100%	1.0–3.2 mm
ABITIG® GRIP Little 150 / 150 F	gas cooled	140 A	100 A	35%	1.0–2.4 mm
ABITIG® GRIP Little 260 W	liquid cooled	240 A	170 A	100%	1.0–3.2 mm
ABITIG® 150 MT	gas cooled	150 A	110 A	60%	1.0–3.2 mm
ABITIG® 260 W MT	liquid cooled	260 A	180 A	100%	1.0–3.2 mm
ABITIG® 200 MT	gas cooled	200 A	140 A	60%	1.6–4.0 mm
ABITIG® 300 W MT	liquid cooled	300 A	210 A	100%	1.6–4.8 mm
ABITIG® 400 W MT	liquid cooled	400 A	280 A	100%	1.6–4.8 mm
ABITIG® 500 W MT	liquid cooled	500 A	350 A	100%	1.6–6.4 mm

Technical Data according to EN 60 974-7

TIG WELDING TORCHES **ABITIG® GRIP**

ABITIG® GRIP 150/F ■ **ABITIG® GRIP 260 W/WF/W SC**

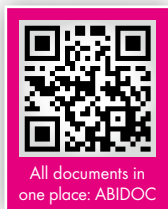

ABITIG® GRIP 150

ABITIG® GRIP 260 W / SC

Special wear parts
see page 158

The SC version
(SC = Super Cooled)
has a red hose coupling.



105-
340 A



ABITIG® GRIP 150

Rating: 150 A DC
105 A AC
Duty cycle: 35%
Tungsten electrodes Ø: 1.0-2.4 mm



ABITIG® GRIP 260 W & WF/SC

Rating: 240/340 A DC
185/240 A AC
Duty cycle: 100%
Tungsten electrodes Ø: 1.0-3.2 mm

Description		Torch body	
Type	Cooling	Version	Part-No.
ABITIG® GRIP 150	gas cooled	Standard - 60.0 mm	776.0010
ABITIG® GRIP 150 F	gas cooled	Flexible - 60.0 mm	776.0130
ABITIG® GRIP 260 W/SC	liquid cooled	Standard - 60.0 mm	777.0010
ABITIG® GRIP 260 WF	liquid cooled	Flexible - 60.0 mm	777.0026.1

Technical data according to EN 60 974-7

Due to the different connection variants on the machine side, it is not possible to list part numbers for complete torches. Please contact our sales department.

Wear parts



Back cap (10 pcs.)	Short 776.0053	Medium 771.0051	Long 772.0051.10
--------------------	-------------------	--------------------	---------------------

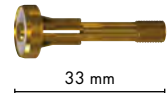
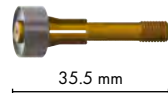
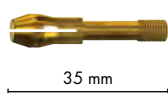

Electrode holder / Gas diffuser (5 pcs.)	Electrode holder	Gas diffuser	Gas diffuser multilayer*	Gas diffuser
Ø 1.0 mm	776.0061	776.0171	777.0171.5	776.0171
Ø 1.6 mm	776.0062	776.0172	777.0172.5	776.0172
Ø 2.0 mm	776.0067	776.0177	777.0177.5	776.0177
Ø 2.4 mm	776.0063	776.0173	777.0173.5	776.0173
Ø 3.2 mm	776.0064	776.0174	777.0174.5	776.0174

* Optimized design for improved gas coverage

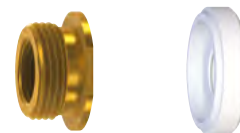

Insulator / Adaptor ring	Standard version (10 pcs.)	for gas diffuser (1 pc.)
Insulator	776.1043	776.0443
Adaptor ring	-	776.0441

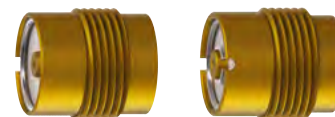

Gas diffuser 4 (1 pc.)	Standard	Multilayer
Ø 1.6 mm	775.0122	775.0127.1
Ø 2.4 mm	775.0123	775.0128.1
Ø 3.2 mm	775.0124	775.0129.1

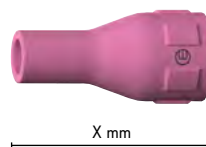
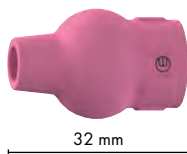

Gas nozzle, ceramic (10 pcs.)	Standard version	Ball version	Standard version		For gas diffuser
			x = 36 mm	x = 60 mm	
Ø 6.5 mm	777.0081	770.0081.10	777.2171	777.2175	-
Ø 8.0 mm	777.0082	770.0082.10	777.2172	777.2176	-
Ø 9.5 mm	777.0083	770.0083.10	777.2173	-	-
Ø 11.0 mm	777.0084	770.0084.10	777.2174	-	-
Ø 12.5 mm	-	-	-	-	778.1183
Ø 16.0 mm	-	-	-	-	778.1184
Ø 19.5 mm	-	-	-	-	778.1188
Ø 24.3 mm	-	-	-	-	778.1189**

**Without figure: cylindrical form, length 34.0 mm; not suitable for high frequency*

TIG WELDING TORCHES **ABITIG® GRIP A T/W T**

ABITIG® GRIP A T 150 ■ **ABITIG® GRIP W T 260 W**



All documents in one place: ABIDOC



ABITIG® GRIP A T 150

Torches with rotatable and exchangeable torch necks



ABITIG® GRIP W T 260 W

105-260 A

Definition:
T = turnable/exchangeable torch neck



ABITIG® GRIP A T 150

Rating: 150 A DC
105 A AC
Duty cycle: 35%
Tungsten electrodes Ø: 1.0-2.4 mm



ABITIG® GRIP W T 260 W

Rating: 260 A DC
185 A AC
Duty cycle: 100%
Tungsten electrodes Ø: 1.0-3.2 mm

Description			
Type	Cooling	Version	Part-No.
Torch neck ABITIG® A T 150	gas cooled	Standard - 60.0 mm	708.1003.1
Torch neck ABITIG® W T 260 W	liquid cooled	Standard - 60.0 mm	709.1004.1
Service kit ABITIG® A T (O-rings, grease etc.)	-	ABITIG® A T	708.0068.1
Service kit ABITIG® WT (O-rings, grease etc.)	-	ABITIG® W T	709.0033.1

Technical data according to EN 60 974-7

Due to the different connection variants on the machine side, it is not possible to list part numbers for complete torches. Please contact our sales department.

Wear parts



Back cap (10 pcs.)	Short 776.0053	Medium 771.0051	Long 772.0051.10
--------------------	-------------------	--------------------	---------------------

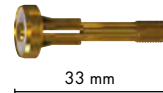
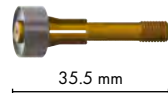
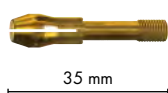

Electrode holder / Gas diffuser (5 pcs.)	Electrode holder	Gas diffuser	Gas diffuser multilayer*	Gas diffuser
Ø 1.0 mm	776.0061	776.0171	777.0171.5	776.0171
Ø 1.6 mm	776.0062	776.0172	777.0172.5	776.0172
Ø 2.0 mm	776.0067	776.0177	777.0177.5	776.0177
Ø 2.4 mm	776.0063	776.0173	777.0173.5	776.0173
Ø 3.2 mm	776.0064	776.0174	777.0174.5	776.0174

* Optimized design for improved gas coverage

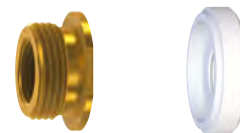

Insulator / Adaptor ring	Standard version (10 pcs.)	for gas diffuser (1 pc.)
Insulator	776.1043	776.0443
Adaptor ring	-	776.0441

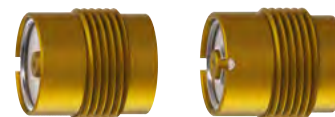

Gas diffuser 4 (1 pc.)	Standard	Multilayer
Ø 1.6 mm	775.0122	775.0127.1
Ø 2.4 mm	775.0123	775.0128.1
Ø 3.2 mm	775.0124	775.0129.1

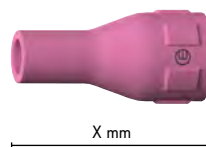
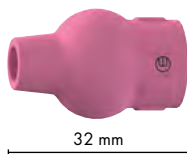

Gas nozzle, ceramic (10 pcs.)	Standard version	Ball version	Standard version		For gas diffuser
			x = 36 mm	x = 60 mm	
Ø 6.5 mm	777.0081	770.0081.10	777.2171	777.2175	-
Ø 8.0 mm	777.0082	770.0082.10	777.2172	777.2176	-
Ø 9.5 mm	777.0083	770.0083.10	777.2173	-	-
Ø 11.0 mm	777.0084	770.0084.10	777.2174	-	-
Ø 12.5 mm	-	-	-	-	778.1183
Ø 16.0 mm	-	-	-	-	778.1184
Ø 19.5 mm	-	-	-	-	778.1188
Ø 24.3 mm	-	-	-	-	778.1189**

**Without figure: cylindrical form, length 34.0 mm; not suitable for high frequency*

TIG WELDING TORCHES **ABITIG® GRIP**

ABITIG® GRIP 200 ■ **ABITIG® GRIP 450 W/SC**



All documents in one place: ABIDOC



ABITIG® GRIP 200

ABITIG® GRIP 450 W / WK / WKF / W SC



ABITIG® GRIP 200

Rating: 200 A DC
140 A AC
Duty cycle: 35 %
Tungsten electrodes Ø: 1.6-3.2 mm



ABITIG® GRIP 450 W / WK / WKF

Rating: 420 A DC / 400 A DC
300 A AC / 280 A AC
Duty cycle: 60% / 100 %
Tungsten electrodes Ø: 1.6-4.8 mm



ABITIG® GRIP 450 W SC

Rating: 480 A DC / 450 A DC
340 A AC / 320 A AC
Duty cycle: 60% / 100 %
Tungsten electrodes Ø: 1.6-4.8 mm

The SC version (SC = Super Cooled) has a red hose coupling.



140-450 A

Description	Torch body		
	Cooling	Version	Part-No.
ABITIG® GRIP 200	gas cooled	Standard - 80.0 mm	774.0010
ABITIG® GRIP 200 F	gas cooled	Flexible - 80.0 mm	774.0130
ABITIG® GRIP 200 K	gas cooled	Short - 60.0 mm	774.0230
ABITIG® GRIP 450 W / 450 W SC	liquid cooled	Standard - 80.0 mm	775.0010
ABITIG® GRIP 450 WK	liquid cooled	Short - 60.0 mm	775.0230
ABITIG® GRIP 450 WF	liquid cooled	Flexible - 80.0 mm	775.0238.1
ABITIG® GRIP 450 WKF	liquid cooled	Short, flexible - 60.0 mm	775.0233.1

The torch bodies (standard and short) for ABITIG® 450 W SC are identical with those for ABITIG® 450 W. The complete torches differ only in terms of the layout of the cable assembly. Technical data according to EN 60 974-7

Due to the different connection variants on the machine side, it is not possible to list part numbers for complete torches. Please contact our sales department.

Wear parts



Back cap (10 pcs.)	Short (10 pcs.)	Medium (1 pc.)	Long (10 pcs.)
	773.0053	773.0055.1	773.0051

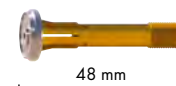

Electrode holder / Gas diffuser (5 pcs.)	Electrode holder	Gas diffuser	Gas diffuser	Gas diffuser
Ø 1.6 mm	775.0062	773.0172	773.0112.5	773.0172
Ø 2.0 mm	775.0067	773.0177	-	773.0177
Ø 2.4 mm	775.0063	773.0173	773.0113	773.0173
Ø 3.2 mm	775.0064	773.0174	773.0114	773.0174
Ø 4.0 mm	775.0065	773.0175	-	773.0175
Ø 4.8 mm	775.0066	773.0176	-	773.0176



Insulator	Standard version (10 pcs.)	For gas diffuser (1 pc.)
	775.1043	775.1143

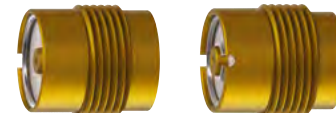

Gas diffuser 4 (1 pc.)	Standard	Multilayer
Ø 1.6 mm	775.0122	775.0127.1
Ø 2.4 mm	775.0123	775.0128.1
Ø 3.2 mm	775.0124	775.0128.1
Ø 4.0 mm	775.0125	775.0130.1
Ø 4.8 mm	775.0126	-



Gas nozzle, ceramic (10 pcs.)	Standard version		Standard version	For gas diffuser
	x = 26 mm	x = 37 mm		
Ø 7.5 mm	-	775.0081	775.2171	-
Ø 10.0 mm	775.0152*	775.0082	775.2172	-
Ø 12.5 mm	-	-	-	778.1183
Ø 13.0 mm	775.0153*	775.0083	775.2173	-
Ø 13.0 mm (boosted)	-	775.0183	-	-
Ø 15.0 mm	-	775.0084	775.2174	-
Ø 15.0 mm (boosted)	-	775.0184	-	-
Ø 16.0 mm	-	-	-	778.1184
Ø 19.5 mm	-	-	-	778.1188
Ø 24.3 mm	-	-	-	778.1189**

*Only in combination with gas diffuser 48 mm (773.0172-773.0177) **Without figure: cylindrical form, length 34.0 mm; not suitable for high frequency.

TIG WELDING TORCHES **ABITIG® GRIP A T/W T**

ABITIG® GRIP A T 200 ■ **ABITIG® GRIP W T 450 W**



All documents in one place: ABIDOC



Torches with rotatable and exchangeable torch necks

ABITIG® GRIP A T 200

ABITIG® GRIP W T 450 W



ABITIG® GRIP A T 200

Rating: 180 A DC
130 A AC
Duty cycle: 35%
Tungsten electrodes Ø: 1.6–3.2 mm



ABITIG® GRIP W T 450 W

Rating: 400 A DC
280 A AC
Duty cycle: 100%
Tungsten electrodes Ø: 1.6–4.8 mm

130–400 A

Definition:

T = turnable/exchangeable torch neck

Description			
Type	Cooling	Version	Part-No.
Torch neck ABITIG® A T 200	gas cooled	Standard - 80.0 mm	708.2003.1
Torch neck ABITIG® W T 450 W	liquid cooled	Standard - 80.0 mm	709.2001.1
Service kit ABITIG® A T (O-rings, grease etc.)	-	ABITIG® A T	708.0068.1
Service kit ABITIG® W T (O-rings, grease etc.)	-	ABITIG® W T	708.0033.1

Technical data according to EN 60 974-7

Due to the different connection variants on the machine side, it is not possible to list part numbers for complete torches. Please contact our sales department.

Wear parts



Back cap (10 pcs.)	Short (10 pcs.)	Medium (1 pc.)	Long (10 pcs.)
	773.0053	773.0055.1	773.0051

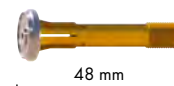

Electrode holder / Gas diffuser (5 pcs.)	Electrode holder	Gas diffuser	Gas diffuser	Gas diffuser
Ø 1.6 mm	775.0062	773.0172	773.0112.5	773.0172
Ø 2.0 mm	775.0067	773.0177	-	773.0177
Ø 2.4 mm	775.0063	773.0173	773.0113	773.0173
Ø 3.2 mm	775.0064	773.0174	773.0114	773.0174
Ø 4.0 mm	775.0065	773.0175	-	773.0175
Ø 4.8 mm	775.0066	773.0176	-	773.0176



Insulator	Standard version (10 pcs.)	For gas diffuser (1 pc.)
	775.1043	775.1143

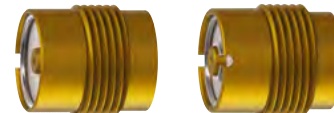

Gas diffuser 4 (1 pc.)	Standard	Multilayer
Ø 1.6 mm	775.0122	775.0127.1
Ø 2.4 mm	775.0123	775.0128.1
Ø 3.2 mm	775.0124	775.0128.1
Ø 4.0 mm	775.0125	775.0130.1
Ø 4.8 mm	775.0126	-

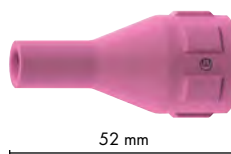

Gas nozzle, ceramic (10 pcs.)	Standard version		Standard version	For gas diffuser
	x = 26 mm	x = 37 mm		
Ø 7.5 mm	-	775.0081	775.2171	-
Ø 10.0 mm	775.0152*	775.0082	775.2172	-
Ø 12.5 mm	-	-	-	778.1183
Ø 13.0 mm	775.0153*	775.0083	775.2173	-
Ø 13.0 mm (boosted)	-	775.0183	-	-
Ø 15.0 mm	-	775.0084	775.2174	-
Ø 15.0 mm (boosted)	-	775.0184	-	-
Ø 16.0 mm	-	-	-	778.1184
Ø 19.5 mm	-	-	-	778.1188
Ø 24.3 mm	-	-	-	778.1189**

*Only in combination with gas diffuser 48 mm (773.0172-773.0177) **Without figure: cylindrical form, length 34.0 mm; not suitable for high frequency.

TIG WELDING TORCH **ABITIG® GRIP**

ABITIG® GRIP 500 W



ABITIG® GRIP 500 W

Special wear parts
see page 158

350-
500 A



ABITIG® GRIP 500 W

Rating: 500 A DC
350 A AC
Duty cycle: 100%
Tungsten electrodes Ø: 1.6-6.4 mm

Description		Torch body	
Type	Cooling	Version	Part-No.
ABITIG® GRIP 500 W	liquid cooled	Standard - 79.0 mm	775.0041.1

Technical data according to EN 60 974-7

Due to the different connection variants on the machine side, it is not possible to list part numbers for complete torches. Please contact our sales department.

Wear parts



Back cap (1 pc.)	Short 775.0053.1	Standard 775.0051.1
------------------	---------------------	------------------------



Insulator (1 pc.)	775.0058.1
-------------------	------------

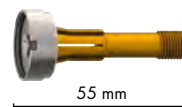
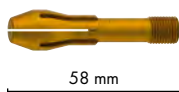

Electrode holder / Gas diffuser (1 pc.)	Electrode holder	Gas diffuser
Ø 1.6 mm	779.6044	779.6058
Ø 2.0 mm	779.6049	779.6063
Ø 2.4 mm	779.6045	779.6059
Ø 3.2 mm	779.6046	779.6060
Ø 4.0 mm	779.6047	779.6061
Ø 4.8 mm	779.6048	779.6062
Ø 6.4 mm	779.6050	779.6064



Gas nozzle, ceramic (10 pcs.)	Standard
Ø 12.5 mm	778.1183
Ø 16.0 mm	778.1184
Ø 19.5 mm	778.1188
Ø 24.0 mm	-



Gas nozzle, ceramic (10 pcs.)		Short
Ø 12.5 mm	-	-
Ø 16.0 mm	-	-
Ø 19.5 mm	-	-
Ø 24.0 mm	-	778.1189*

*Not suitable for high frequency

TIG WELDING TORCHES **ABITIG® GRIP LITTLE**

ABITIG® GRIP LITTLE 90 ■ **ABITIG® GRIP LITTLE 180 W**



All documents in
one place: ABIDOC



ABITIG® GRIP LITTLE 90

ABITIG® GRIP LITTLE 180 W



ABITIG® GRIP Little 90

Rating: 90 A DC
60 A AC
Duty cycle: 35%
Tungsten electrodes Ø: 1.0-1.6 mm



ABITIG® GRIP Little 180 W

Rating: 180 A DC
130 A AC
Duty cycle: 100%
Tungsten electrodes Ø: 1.0-3.2 mm

60-
180 A

Description		Torch body	
Type	Cooling	Version	Part-No.
ABITIG® GRIP Little 90	gas cooled	Standard - 60.0 mm	770.0040.1
ABITIG® GRIP Little 180 W	liquid cooled	Standard - 60.0 mm	772.0040.1

Technical data according to EN 60 974-7

Due to the different connection variants on the machine side, it is not possible to list part numbers for complete torches. Please contact our sales department.

Wear parts



Back cap (10 pcs.)	Short	Standard
	771.0053	771.0051

C

Spring (10 pcs.)	771.0037
------------------	----------



Electrode holder / Gas diffuser (5 pcs.)	Electrode holder	Gas diffuser	Gas diffuser cylindrical
Ø 1.0 mm	771.0061	771.0111	-
Ø 1.6 mm	771.0062	771.0112	-
Ø 2.0 mm	771.0067	771.0117	-
Ø 2.4 mm	771.0063	771.0113	771.0123
Ø 3.2 mm	771.0064	771.0114	771.0124



Gas nozzle, ceramic (10 pcs.)	Standard	Standard
Ø 6.0 mm (Gr. 1)	771.0081	-
Ø 8.0 mm (Gr. 2)	771.0082	-
Ø 10.5 mm (Gr. 3)	771.0083	771.0083

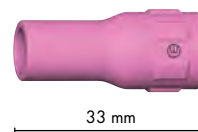

Gas nozzle, ceramic (10 pcs.)	Long	Long
Ø 6.0 mm (Gr. 1)	771.2171	-
Ø 8.0 mm (Gr. 2)	771.2172	-
Ø 10.5 mm (Gr. 3)	771.2173	771.2173

TIG WELDING TORCHES **ABITIG® GRIP LITTLE**

ABITIG® GRIP LITTLE 150/F ■ **ABITIG® GRIP LITTLE 260 W/WF**

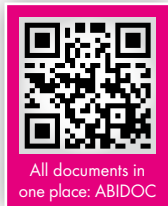

ABITIG® GRIP LITTLE 150

ABITIG® GRIP LITTLE 260 W

**Special wear parts
see page 158**

**100–
240 A**



ABITIG® GRIP Little 150/F

Rating: 140 A DC
100 A AC
Duty cycle: 35%
Tungsten electrodes Ø: 1.0–2.4 mm



ABITIG® GRIP Little 260 W/WF

Rating: 240 A DC
170 A AC
Duty cycle: 100%
Tungsten electrodes Ø: 1.0–3.2 mm

Description		Torch body	
Type	Cooling	Version	Part-No.
ABITIG® GRIP LITTLE 150	gas cooled	Standard - 46.0 mm	770.0010.1
ABITIG® GRIP LITTLE 150 F	gas cooled	Flexible - 46.0 mm	770.0130.1
ABITIG® GRIP LITTLE 260 W	liquid cooled	Standard - 46.0 mm	772.0010.1
ABITIG® GRIP LITTLE 260 WF	liquid cooled	Flexible - 46.0 mm	772.0037.1

Technical data according to EN 60 974-7

Due to the different connection variants on the machine side, it is not possible to list part numbers for complete torches. Please contact our sales department.

Wear parts



Back cap (10 pcs.)	Short	Medium	Long
	776.0053	771.0051	772.0051.10

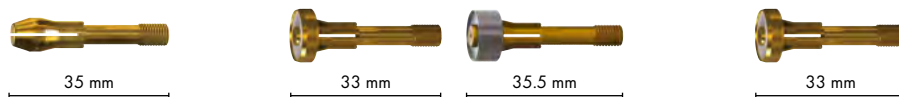

Electrode holder / Gas diffuser (5 pcs.)	Electrode holder	Gas diffuser	Gas diffuser multilayer*	Gas diffuser
Ø 1.0 mm	776.0061	776.0171	777.0171.5	776.0171
Ø 1.6 mm	776.0062	776.0172	777.0172.5	776.0172
Ø 2.0 mm	776.0067	776.0177	777.0177.5	776.0177
Ø 2.4 mm	776.0063	776.0173	777.0173.5	776.0173
Ø 3.2 mm	776.0064	776.0174	777.0174.5	776.0174

* Optimized design for improved gas coverage



Insulator / Adaptor ring	Standard version (10 pcs.)	for gas diffuser (1 pc.)
Insulator	776.1043	776.0443
Adapting	-	776.0441

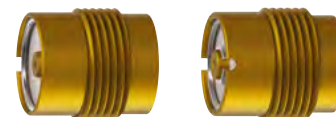

Gas diffuser 4 (1 pc.)	Standard	Multilayer
Ø 1.6 mm	775.0122	775.0127.1
Ø 2.4 mm	775.0123	775.0128.1
Ø 3.2 mm	775.0124	775.0129.1

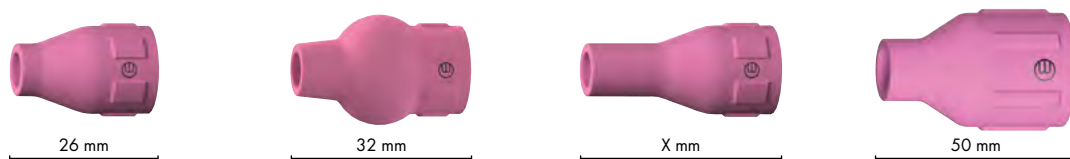

Gas nozzle, ceramic (10 pcs.)	Standard version	Ball version	Standard version		for gas diffuser
			x = 36 mm	x = 60 mm	
Ø 6.5 mm	777.0081	770.0081.10	777.2171	777.2175	-
Ø 8.0 mm	777.0082	770.0082.10	777.2172	777.2176	-
Ø 9.5 mm	777.0083	770.0083.10	777.2173	-	-
Ø 11.0 mm	777.0084	770.0084.10	777.2174	-	-
Ø 12.5 mm	-	-	-	-	778.1183
Ø 16.0 mm	-	-	-	-	778.1184
Ø 19.5 mm	-	-	-	-	778.1188
Ø 24.3 mm	-	-	-	-	778.1189**

**Without figure: cylindrical form, length 34.0 mm; not suitable for high frequency.

TIG WELDING TORCHES **ABITIG® MT**

ABITIG® 150 MT ■ **ABITIG® 260 W MT**

Advantages of the machine torches **ABITIG® MT**

- BINZEL style wear part concept
- With pre-settable tungsten electrode for quick, easy and repeatable electrode exchange (ABITIG® 200 MT/300 W MT/450 W MT)
- Cable assembly for all common TIG welding power sources
- Compact design and robust construction



ABITIG® 260 W MT

ABITIG® 150 MT

Special wear parts and torch mounts see page 158



ABITIG® 150 MT

Rating: 150 A DC
110 A AC
Duty cycle: 60%
Tungsten electrodes Ø: 1.0-3.2 mm



ABITIG® 260 W MT

Rating: 260 A DC
180 A AC
Duty cycle: 100%
Tungsten electrodes Ø: 1.0-3.2 mm

110-260 A

Description		Torch body	
Type	Cooling	Version	Part-No.
ABITIG® 150 MT	gas cooled	Standard - 214.0 mm	778.1020
ABITIG® 260 W MT	liquid cooled	Standard - 214.0 mm	779.1020

Technical data according to EN 60 974-7

Due to the different connection variants on the machine side, it is not possible to list part numbers for complete torches. Please contact our sales department.

Wear parts



Guide tube (1 pc.)	779.1030
--------------------	----------

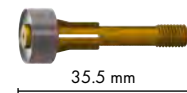
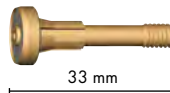
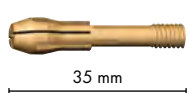

Electrode holder / Gas diffuser (5 pcs.)	Electrode holder	Gas diffuser	Gas diffuser
Ø 1.0 mm	776.0061	776.0171	777.0171.5
Ø 1.6 mm	776.0062	776.0172	777.0172.5
Ø 2.0 mm	776.0067	776.0177	777.0177.5
Ø 2.4 mm	776.0063	776.0173	777.0173.5
Ø 3.2 mm	776.0064	776.0174	777.0174.5



Insulator (1 pc.)	779.1043
-------------------	----------

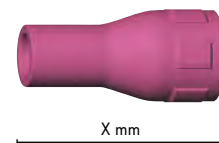
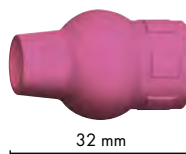

Gas nozzle, ceramic (10 pcs.)	Standard version	Ball version	Long version	
			X = 36 mm	X = 60 mm
Ø 6.5 mm	777.0081	770.0081.10	777.2171	777.2175
Ø 8.0 mm	777.0082	770.0082.10	777.2172	777.2176
Ø 9.5 mm	777.0083	770.0083.10	777.2173	-
Ø 11.0 mm	777.0084	770.0084.10	777.2174	-

TIG WELDING TORCHES **ABITIG® MT**

ABITIG® 200 MT ■ ABITIG® 300 W MT ■ ABITIG® 450 W MT



ABITIG® 200 MT
ABITIG® 300 W MT

ABITIG® 450 W MT

Torch mounts see page 159



ABITIG® 200 MT

Rating: 200 A DC
140 A AC
Duty cycle: 60%
Tungsten Electrodes Ø: 1.6-4.0 mm



ABITIG® 300 W MT

Rating: 300 A DC
210 A AC
Duty cycle: 100%
Tungsten Electrodes Ø: 1.6-4.8 mm



ABITIG® 450 W MT

Rating: 450 A DC
320 A AC
Duty cycle: 100%
Tungsten electrodes Ø: 1.6-4.8 mm

140-450 A

Description		Torch body	
Type	Cooling	Version	Part-No.
ABITIG® 200 MT	gas cooled	Standard - 249.0 mm	778.2020
ABITIG® 300 W MT	liquid cooled	Standard - 249.0 mm	779.2020
ABITIG® 450 W MT	liquid cooled	Standard - 255.0 mm	779.2019.1

Technical data according to EN 60 974-7

Due to the different connection variants on the machine side, it is not possible to list part numbers for complete torches. Please contact our sales department.

Wear parts

ABITIG® 200 MT/ABITIG® 300 W MT

ABITIG® 450 W MT



Guide tub (1 pc.)	778.1030
-------------------	----------



Collet (1 pc.)	778.1140
----------------	----------

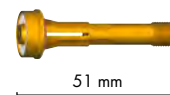
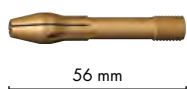

Electrode holder / Gas diffuser (5 pcs.)	Electrode holder	Gas diffuser	Gas diffuser
Ø 1.6 mm	775.0062	773.0172	773.0112.5
Ø 2.0 mm	775.0067	773.0177	-
Ø 2.4 mm	775.0063	773.0173	773.0113
Ø 3.2 mm	775.0064	773.0174	773.0114
Ø 4.0 mm	775.0065	773.0175	-
Ø 4.8 mm	775.0066	773.0176	-



Insulator (1 pc.)	775.1043	779.6033
-------------------	----------	----------

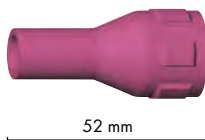
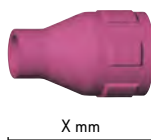

Gas diffuser, ceramic (10 pcs.)	Standard version		Long version	Short version	Standard version
	X = 26 mm	X = 37 mm			
Ø 7.5 mm	-	775.0081	775.2171	-	-
Ø 10.0 mm	775.0152	775.0082	775.2172	-	-
Ø 12.5 mm	-	-	-	-	778.1183
Ø 13.0 mm	775.0153	775.0083	775.2173	-	-
Ø 13.0 mm (boosted)	-	775.0183	-	-	-
Ø 15.0 mm	-	775.0084	775.2174	-	-
Ø 15.0 mm (boosted)	-	775.0184	-	-	-
Ø 16.0 mm	-	-	-	-	778.1184
Ø 19.5 mm	-	-	-	-	778.1188
Ø 24.0 mm	-	-	-	778.1189	-



Setting gauge (1 pc.)	778.1157
-----------------------	----------

Further options, e.g. the "Jumbo" version up to ND 24 or metal gas nozzles, please see chapter 10 of our spare parts list - this you can find in the download area of our website www.binzel-abicor.com.

TIG WELDING TORCHES **ABITIG® MT**

ABITIG® 400 W MT ■ **ABITIG® 500 W MT**



ABITIG® 500 W MT

ABITIG® 400 W MT

280-500 A

Special wear parts and torch mounts see page 159



ABITIG® 400 W MT

Rating: 400 A DC
280 A AC
Duty cycle: 100%
Tungsten electrodes Ø: 1.6-4.8 mm



ABITIG® 500 W MT

Rating: 500 A DC
350 A AC
Duty cycle: 100%
Tungsten electrodes Ø: 1.6-6.4 mm

Description		Torch body	
Type	Cooling	Version	Part-No.
ABITIG® 400 W MT	liquid cooled	Standard - 228.0 mm	779.4020
ABITIG® 500 W MT	liquid cooled	Standard - 265.0 mm	779.6020

Technical data according to EN 60 974-7

Due to the different connection variants on the machine side, it is not possible to list part numbers for complete torches. Please contact our sales department.

Wear parts

ABITIG® 400 W MT

ABITIG® 500 W MT



Guide tube (1 pc.)	779.4030	779.6026
---------------------------	----------	----------

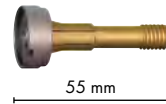
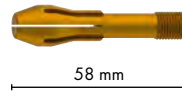
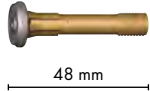

Electrode holder / Gas diffuser (5 pcs.)	Electrode holder (5 pcs.)	Gas diffuser (5 pcs.)	Electrode holder (1 pc.)	Gas diffuser (1 pc.)
Ø 1.6 mm	775.0062	773.0172	779.6044	779.6058
Ø 2.0 mm	775.0067	773.0177	779.6049	779.6063
Ø 2.4 mm	775.0063	773.0173	779.6045	779.6059
Ø 3.2 mm	775.0064	773.0174	779.6046	779.6060
Ø 4.0 mm	775.0065	773.0175	779.6047	779.6061
Ø 4.8 mm	775.0066	773.0176	779.6048	779.6062
Ø 6.4 mm	-	-	779.6050	779.6064



Insulator (1 pc.)	779.4043	779.6033
--------------------------	----------	----------

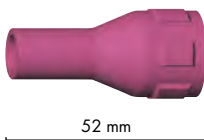

Gas diffuser, ceramic (10 pcs.)			Long version	Short version	Standard version
	X = 26 mm	X = 37 mm			
Ø 7.5 mm	-	775.0081	775.2171	-	-
Ø 10.0 mm	775.0152	775.0082	775.2172	-	-
Ø 12.5 mm	-	-	-	-	778.1183
Ø 13.0 mm	775.0153	775.0083	775.2173	-	-
Ø 13.0 mm (reinforced)	-	775.0183	-	-	-
Ø 15.0 mm	-	775.0084	775.2174	-	-
Ø 15.0 mm (reinforced)	-	775.0184	-	-	-
Ø 16.0 mm	-	-	-	-	778.1184
Ø 19.5 mm	-	-	-	-	778.1188
Ø 24.0 mm	-	-	-	778.1189	-

TIG WELDING TORCHES **ABITIG®** ■ **ABITIG® MT** WITH COLD WIRE FEED

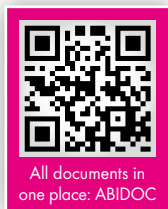

ABITIG® GRIP 450 W

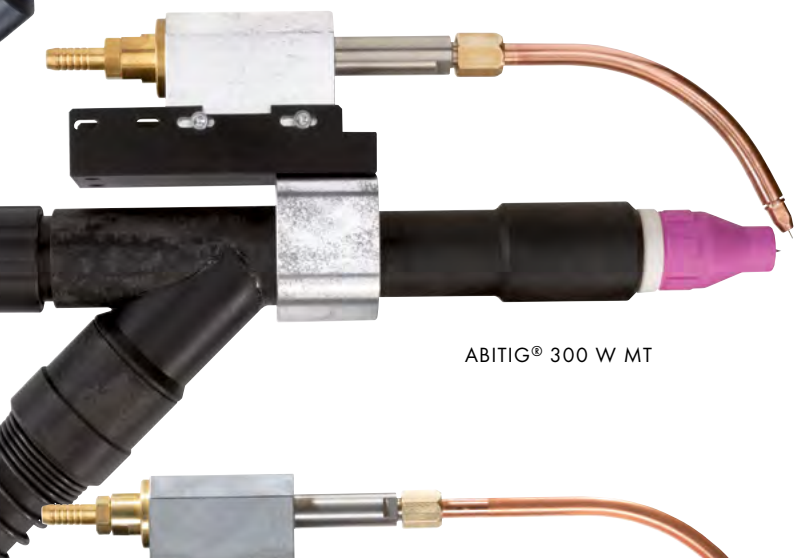

ABITIG® 300 W MT



ABITIG® 500 W MT

Special wear parts and torch mounts see page 159

140–500 A

- BINZEL style wear part concept
- Three-dimensionally adjustable
- Perfect fit for every wire diameter
- Robust and precise



ABITIG® 200 MT / ABITIG® GRIP 200*

Rating: 200 A DC
140 A AC
Duty cycle: 35%
Tungsten electrodes: Ø 1.6–3.2 mm



ABITIG® 260 W MT / ABITIG® GRIP 260 W*

Rating: 260 A DC
180 A AC
Duty cycle: 100%
Tungsten electrodes: Ø 1.0–3.2 mm



ABITIG® 300 W MT*

Rating: 300 A DC
210 A AC
Duty cycle: 100%
Tungsten electrodes: Ø 1.6–4.8 mm



ABITIG® 400 W MT*

Rating: 400 A DC
280 A AC
Duty cycle: 100%
Tungsten electrodes: Ø 1.6–4.8 mm



ABITIG® GRIP 450 W*

Rating: 400 A DC
280 A AC
Duty cycle: 100%
Tungsten electrodes: Ø 1.6–4.8 mm



ABITIG® 500 W MT*

Rating: 500 A DC
350 A AC
Duty cycle: 100%
Tungsten electrodes: Ø 1.6–6.4 mm

*Technical data according to EN 60 974-7

Due to the different connection variants on the machine side, it is not possible to list part numbers for complete torches. Please contact our sales department.

Torches complete

TIG Manual Welding Torches ABITIG® with cold wire feed			
Type	Cooling	Version	Part-No.
ABITIG® GRIP 200	gas cooled	4 m BIS-V2, BHC-12, GZ, with cold wire feed*	525.2097.1
ABITIG® GRIP 260 W	liquid cooled	4 m BIS-V2, BHC-12, WZ, with cold wire feed*	525.2092.1
ABITIG® GRIP 450 W	liquid cooled	4 m BIS-V2, BHC-12, WZ, with cold wire feed*	525.2094.1

These cable assemblies are configured exclusively for use with ABIDRIVE V2 – an intermediate cable assembly is required. Our standard cable assemblies and the retrofit kits listed below are available for use with systems from other manufacturers.

TIG Machine Welding Torches ABITIG® with cold wire feed			
Type	Cooling	Version	Part-No.
ABITIG® 200 MT	gas cooled	4 m with cold wire feed*	525.1015
ABITIG® 260 W MT	liquid cooled	4 m with cold wire feed*	525.1018
ABITIG® 300 W MT	liquid cooled	4 m with cold wire feed*	525.1023
ABITIG® 400 W MT	liquid cooled	4 m with cold wire feed*	525.1026
ABITIG® 500 W MT	liquid cooled	4 m with cold wire feed*	525.1042.1

These cable assemblies are configured exclusively for use with ABIDRIVE V2 – an intermediate cable assembly is required. Our standard cable assemblies and the retrofit kits listed below are available for use with systems from other manufacturers.

Retrofit kits

Retrofit kits	
Description	Part-No.
Cold wire feeding compl. for ABITIG® 260 W (gas nozzle L = 36 mm)*	729.0084
Cold wire feeding compl. for ABITIG® 450 W (gas nozzle L = 37 mm)*	729.0070
Cold wire feeding compl. for ABITIG® MT 260 W / 300 W / 400 W*	779.6514.1
Cold wire feeding compl. for ABITIG® MT 500 W*	779.6500
Wire conduit ABIDRIVE (L = 6.00 m) incl. fastening material applicable for all retrofit kits	525.1014

*including cold wire feeding tip 1.0 mm

Wear parts

Cold wire feeding tip	ABITIG®	ABITIG® MT
Diameter	Part-No. (2 pcs.)	Part-No. (5 pcs.)
Ø 0.8 mm	729.0092.2	967.0329
Ø 1.0 mm	729.0093.2	967.0330
Ø 1.2 mm	729.0094.2	967.0331
Ø 1.6 mm	729.0095.2	967.0332

Cold wire feeding		
Type	Description	Part-No.
ABITIG®	Cold wire guide liner 2.0x4.5 mm (L=0.45 m)	729.0080
	Double nipple	729.0057
ABITIG® MT	Cold wire feeding tube for ABITIG® MT 260 W / 300 W / 400 W	779.6513.1
	Cold wire feeding tube for ABITIG® MT 500 W	967.0326
	optional: Cold wire feeding tube for ABITIG® MT 500 W – liquid cooled	779.6505

Wire guides	
Description	Part-No.
Carbon PTFE core liner 2.0/4.0; Wire-Ø 1.0–1.2; for 4.00 m	127.0007
Polyamid core liner 2.0/4.0; Wire-Ø 1.0–1.2; for 4.00 m	128.0015
Polyamid core liner 2.0x4.0; Wire-Ø 1.0–1.2; for 6.00 m	128.0017
Polyamid core liner 2.3x4.7; Wire-Ø 1.6; for 6.00 m	128.0037



WELDING TORCHES STANDARD STYLE

TIG WELDING TORCHES **STANDARD STYLE**

Standard style:

- ✓ **International standard wear part system**
- ✓ **Various configurations**
- ✓ **Proven ABICOR BINZEL quality**

International standard wear part system

The wear part system corresponds to the standard concept and ensures that wear parts are available for these welding torches anywhere in the world. This gives you a high degree of flexibility when using "Standard style" TIG welding torches.

Various configurations

The cable assemblies are modular and can be equipped with all the necessary machine-side connections.

Proven ABICOR BINZEL quality

The well-known torch quality of the original manufacturer guarantees comfortable handling, low-strain welding and very good welding results.

Overview of rating ABITIG® welding torches "Standard style"

A (DC)

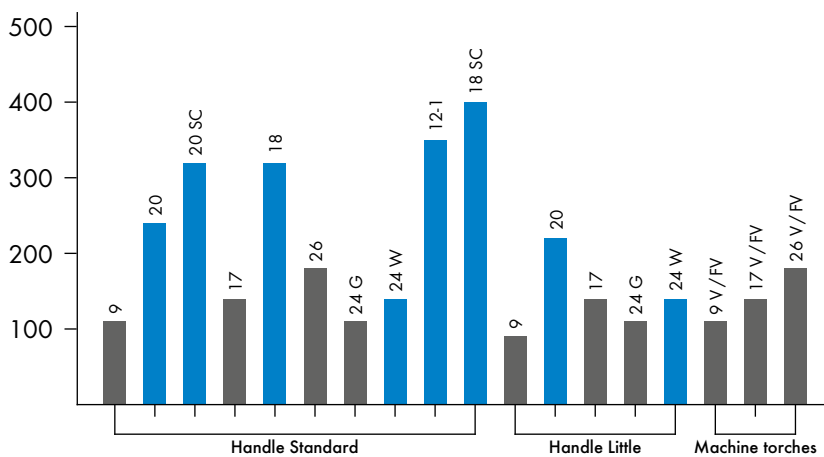

GAS COOLED LIQUID COOLED

- 2K handle with grip inlay and excellent ergonomics
- Excellent grip safety, including ultra-small handle design in the Little version
- Robust switching and control functions in the handle
- Ball joint for optimum range of movement and ideal handling
- Lightweight, flexible leather cable assemblies made from high flex leather (HFL)
- For all common TIG power sources
- Excellent HF safety



Type	Cooling	DC	AC	Duty cycle	Tungsten electrodes Ø
ABITIG® GRIP 9	gas cooled	110 A	80 A	35%	0.5-1.6 mm
ABITIG® GRIP 20	liquid cooled	240 A	170 A	100%	0.5-3.2 mm
ABITIG® GRIP 20 SC	liquid cooled	320 A	220 A	100%	0.5-3.2 mm
ABITIG® GRIP 17	gas cooled	140 A	110 A	35%	0.5-2.4 mm
ABITIG® GRIP 18	liquid cooled	320 A	230 A	100%	0.5-4.0 mm
ABITIG® GRIP 26	gas cooled	180 A	130 A	35%	0.5-4.0 mm
ABITIG® GRIP 24 G	gas cooled	110 A	80 A	35%	0.5-1.6 mm
ABITIG® GRIP 24 W	liquid cooled	140 A	100 A	100%	0.5-2.4 mm
ABITIG® GRIP 12-1	liquid cooled	350 A	250 A	100%	1.6-4.0 mm
ABITIG® GRIP 18 SC	liquid cooled	400 A	280 A	100%	0.5-4.8 mm
ABITIG® GRIP Little 9	gas cooled	110 A	80 A	35%	0.5-1.6 mm
ABITIG® GRIP Little 20	liquid cooled	220 A	150 A	100%	0.5-3.2 mm
ABITIG® GRIP Little 17	gas cooled	140 A	100 A	35%	0.5-2.4 mm
ABITIG® GRIP Little 24 G	gas cooled	110 A	80 A	35%	0.5-1.6 mm
ABITIG® GRIP Little 24 W	liquid cooled	140 A	100 A	100%	0.5-2.4 mm
ABITIG® 9 V/FV	gas cooled	110 A	80 A	35%	0.5-1.6 mm
ABITIG® 17 V/FV	gas cooled	140 A	100 A	35%	0.5-2.4 mm
ABITIG® 26 V/FV	gas cooled	180 A	130 A	35%	0.5-4.0 mm

Technical data according to EN 60 974-7

TIG WELDING TORCHES **ABITIG® GRIP**

ABITIG® GRIP 9 ■ **ABITIG® GRIP 20/20 SC**

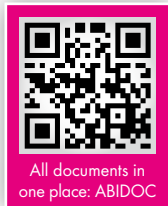

ABITIG® GRIP 9

ABITIG® GRIP 20/20 SC

Special wear parts see page 156

The SC version (SC = Super Cooled) has a red hose coupling.

80-240 A



ABITIG® GRIP 9

Rating: 110 A DC
80 A AC
Duty cycle: 35%
Tungsten Electrodes Ø: 0.5-1.6 mm



ABITIG® GRIP 20/20 SC

Rating: 240 A DC / 320 A DC
170 A AC / 220 A AC
Duty cycle: 100%
Tungsten Electrodes Ø: 0.5-3.2 mm

Description		Torch body	
Type	Cooling	Version	Part-No.
ABITIG® GRIP 9	gas cooled	Standard - 46.0 mm	712.5020
ABITIG® GRIP 9 F	gas cooled	Flexible - 46.0 mm	712.5030
ABITIG® GRIP 20/20 SC	liquid cooled	Standard - 46.0 mm	712.3020
ABITIG® GRIP 20 F	liquid cooled	Flexible - 46.0 mm	712.3030
ABITIG® GRIP 20 F	liquid cooled	Flexible - 75.0 mm	712.3040.1
ABITIG® GRIP 20 F	liquid cooled	Flexible - 110.0 mm	712.3050.1

Technical data according to EN 60 974-7

Due to the different connection variants on the machine side, it is not possible to list part numbers for complete torches. Please contact our sales department.

Wear parts



Back cap (10 pcs.)	Short	Medium	Long
	701.0240 / 41V33	701.0244 / 41V35	701.0247 / 41V24

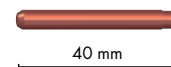
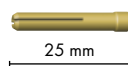
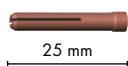

Collet (10 pcs.)	Standard version	Brass version	Jumbo version
Ø 0.5 mm	701.0249 / 13N20	701.1060	701.1225 / 13N20L
Ø 1.0 mm	701.0250 / 13N21	701.1061	701.1226 / 13N21L
Ø 1.2 mm	701.0254 / -	-	-
Ø 1.6 mm	701.0251 / 13N22	701.1019	701.1227 / 13N22L
Ø 2.0 mm	701.0255 / -	-	-
Ø 2.4 mm	701.0252 / 13N23	701.1020	701.1228 / 13N23L
Ø 3.2 mm	701.0253 / 13N24	701.1063	701.1229 / 13N24L



Insulating ring / Adaptor	Insulating ring (10 pcs.)	Adaptor (5 pcs.)
	702.0055 / 598882	701.1234 / 54N63-20



Collet body (10 pcs.)	Standard version	Standard version with gas lens	Jumbo version with gas lens
Ø 0.5-1.0 mm	701.0275 / 13N26	701.0301 / 45V42	701.1230 / 45V0204S
Ø 1.2 mm	701.0279 / -	701.0313 / -	-
Ø 1.6 mm	701.0276 / 13N27	701.0307 / 45V43	701.1231 / 45V116S
Ø 2.0 mm	701.0280 / -	701.0315 / -	-
Ø 2.4 mm	701.0277 / 13N28	701.0309 / 45V44	701.1232 / 45V64S
Ø 3.2 mm	701.0278 / 13N29	701.0311 / 45V45	701.1233 / 995795S



Gas nozzle, ceramic (10 pcs.)	Standard version	Standard version for gas lens	Jumbo version for gas lens
No. 4 Ø 6.5 mm	701.0281 / 13N08	701.0317 / 53N58	-
No. 5 Ø 8.0 mm	701.0282 / 13N09	701.0318 / 53N59	-
No. 6 Ø 9.5 mm	701.0283 / 13N10	701.0319 / 53N60	701.1199 / 57N75
No. 7 Ø 11.0 mm	701.0284 / 13N11	701.0320 / 53N61	-
No. 8 Ø 12.5 mm	701.0285 / 13N12	701.0322 / 53N61S	701.1200 / 57N74
No. 10 Ø 16.0 mm	701.0286 / 13N13	-	701.1201 / 53N88
No. 12 -	-	-	701.1121 / 53N87

Gas nozzle, ceramic (10 pcs.)	Version			X1	Part-No.
	Standard	Gr. 4	Ø 6.5 mm	48 mm	701.0289 / 796F71
	Standard	Gr. 5	Ø 8.0 mm	48 mm	701.0290 / 796F72
	Standard	Gr. 6	Ø 9.5 mm	48 mm	701.0291 / 796F73
	Standard	Gr. 4	Ø 6.5 mm	63 mm	701.0293 / 796F75
	Standard	Gr. 5	Ø 8.0 mm	63 mm	701.0294 / 796F76
	Standard	Gr. 4	Ø 6.5 mm	89 mm	701.0296 / 796F79

Gas nozzle, ceramic (10 pcs.)	Version	Length	Part-No.
	Jumbo version for gas lens*	48 mm	701.1202 / 53N89

*not suitable for high frequency

TIG WELDING TORCHES **ABITIG® GRIP**

ABITIG® GRIP 17 ■ **ABITIG® GRIP 18** ■ **ABITIG® GRIP 26**

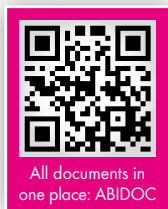

ABITIG® GRIP 17

ABITIG® GRIP 18

ABITIG® GRIP 26

**Further wear parts
see page 157**

**100 –
320 A**



ABITIG® GRIP 17

Rating: 140 A DC
100 A AC
Duty cycle: 35%
Tungsten electrodes Ø: 0.5-2.4 mm



ABITIG® GRIP 18

Rating: 320 A DC
230 A AC
Duty cycle: 100%
Tungsten electrodes Ø: 0.5-4.0 mm



ABITIG® GRIP 26

Rating: 180 A DC
130 A AC
Duty cycle: 35%
Tungsten electrodes Ø: 0.5-4.0 mm

Description		Torch body	
Type	Cooling	Version	Part-No.
ABITIG® GRIP 17	gas cooled	Standard - 65.0 mm	712.1020
ABITIG® GRIP 17 F	gas cooled	Flexible - 65.0 mm	712.1030
ABITIG® GRIP 18	liquid cooled	Standard - 69.0 mm	712.2020
ABITIG® GRIP 18 F	liquid cooled	Flexible - 69.0 mm	712.2030
ABITIG® GRIP 18 K	liquid cooled	Short - 59.0 mm	712.2230
ABITIG® GRIP 26	gas cooled	Standard - 79.0 mm	712.4020
ABITIG® GRIP 26 F	gas cooled	Flexible - 79.0 mm	712.4030
ABITIG® GRIP 26 K	gas cooled	Short - 59.0 mm	712.4230

Technical data according to EN 60 974-7

Due to the different connection variants on the machine side, it is not possible to list part numbers for complete torches. Please contact our sales department.

Wear parts



Back cap (10 pcs.)	Short	Long
	712.1053	712.1051



Collet (10 pcs.)	Version 50 mm	Version 52 mm
Ø 0.5 mm	702.0005 / 10N21	701.0169 / 10N21D
Ø 1.0 mm	702.0006 / 10N22	701.0171 / 10N22D
Ø 1.2 mm	702.0007 / -	701.0170 / -
Ø 1.6 mm	702.0008 / 10N23	701.0172 / 10N23D
Ø 2.0 mm	702.0012 / -	701.0176 / -
Ø 2.4 mm	702.0009 / 10N24	701.0173 / 10N24D
Ø 3.2 mm	702.0010 / 10N25	701.0174 / 10N25D
Ø 4.0 mm	702.0011 / 54N20	701.0175 / 54N20D



Insulating ring/Adaptor	Insulating ring (10 pcs.)	Adaptor (10 pcs.)	Adaptor (5 pcs.)
	703.0012 / 18CG	701.0130 / 54N01	701.1122 / 54N63

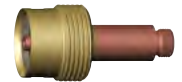
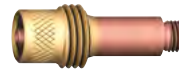

Collet body (10 pcs.)	Standard version	Standard version with gas lens	JumboVersion with gas lens
Ø 0.5 - 1.2 mm	701.0190 / 10N30	701.0201 / 45V24	-
Ø 1.6 mm	701.0191 / 10N31	701.0203 / 45V25	701.1116 / 45V116
Ø 2.0 mm	701.0196 / 10N32	701.0207 / 45V26	-
Ø 2.4 mm	701.0196 / 10N32	701.0207 / 45V26	701.1117 / 45V64
Ø 3.2 mm	701.0197 / 10N28	701.0209 / 45V27	701.1118 / 995795
Ø 4.0 mm	701.0198 / 406488	701.0211 / 45V28	701.1208 / 45V63

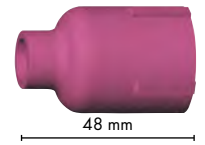
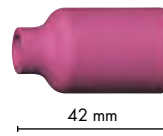
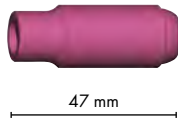

Gas nozzle, ceramic (10 pcs.)		Standard version	Standard version for gas lens	Jumbo version for gas lens
No. 4	Ø 6.5 mm	701.0107 / 10N50	701.0420 / 54N18	-
No. 5	Ø 8.0 mm	701.0108 / 10N49	701.0421 / 54N17	-
No. 6	Ø 9.5 mm	701.0109 / 10N48	701.0422 / 54N16	701.1199 / 57N75
No. 7	Ø 11.0 mm	701.0110 / 10N47	701.0423 / 54N15	-
No. 8	Ø 12.5 mm	701.0111 / 10N46	701.0424 / 54N14	701.1200 / 57N74
No. 10	Ø 16.0 mm	701.0113 / 10N45	-	701.1201 / 53N88
No. 12	Ø 19.5 mm	701.0114 / 10N44*	701.0426 / 54N19	701.1121 / 53N87

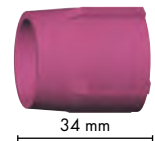
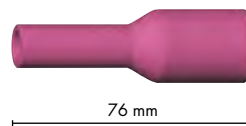
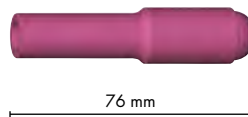

Gas nozzle, ceramic (10 pcs.)		Standard version	Standard version for gas lens	Jumbo version for gas lens
No. 5	Ø 8.0 mm	701.0115 / 10N49L	701.0427 / 54N17L	-
No. 6	Ø 9.5 mm	701.0116 / 10N48L	701.0428 / 54N16L	-
No. 7	Ø 11.0 mm	701.0117 / 10N47L	701.0429 / 54N15L	-
	Ø 24.0 mm	-	-	701.1202 / 53N89

*Length 50 mm **not suitable for high frequency

TIG WELDING TORCHES **ABITIG® GRIP**

ABITIG® GRIP 24 G ■ **ABITIG® GRIP 24 W**

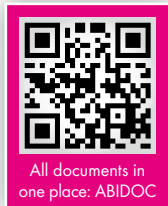

ABITIG® GRIP 24 G

ABITIG® GRIP 24 W



ABITIG® GRIP 24 G

Rating: 110 A DC
80 A AC
Duty cycle: 35%
Tungsten electrodes Ø: 0.5-1.6 mm



ABITIG® GRIP 24 W

Rating: 140 A DC
100 A AC
Duty cycle: 100%
Tungsten electrodes Ø: 0.5-2.4 mm

80-140 A

Description		Torch body	
Type	Cooling	Version	Part-No.
ABITIG® GRIP 24 G	gas cooled	Standard - 55.0 mm	712.7020
ABITIG® GRIP 24 W	liquid cooled	Standard - 55.0 mm	712.7120

Technical data according to EN 60 974-7

Due to the different connection variants on the machine side, it is not possible to list part numbers for complete torches. Please contact our sales department.

Wear parts



Insulating sleeve/Insulator (10 pcs.)	Insulating sleeve 701.0458/53N22	Insulator for gas lens 701.0459/53N66
---------------------------------------	-------------------------------------	--

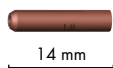

Collet (10 pcs.)	Standard version	Standard version for gas lens
Ø 0.5 mm	-	-
Ø 1.0 mm	701.0453/53N16	701.0462/53N63
Ø 1.2 mm	701.0455/-	-
Ø 1.6 mm	701.0454/53N14	701.0463/53N64
Ø 2.0 mm	701.0456/-	701.0466/-
Ø 2.4 mm	701.0457/24C332	701.0465/24GLC332



Collet body (10 pcs.)	Standard version	Standard version with gas lens
Ø 0.5 mm	701.0479/53N17	701.0301/45V41
Ø 1.0 mm	701.0480/53N18	701.0301/45V42
Ø 1.2 mm	701.0483/-	701.0313/-
Ø 1.6 mm	701.0481/53N19	701.0307/45V43
Ø 2.0 mm	701.0484/-	701.0315/-
Ø 2.4 mm	701.0482/24CB332	701.0309/45V44

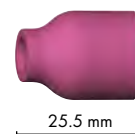

Gas nozzle, ceramic (10 pcs.)			Standard version	Standard version for gas lens
No. 4	Ø 6.5 mm		701.0468/53N24	701.0317/53N58
No. 5	Ø 8.0 mm		701.0469/53N25	701.0318/53N59
No. 6	Ø 9.5 mm		701.0470/53N27	701.0319/53N60
No. 7	Ø 11.0 mm		-	701.0320/53N61

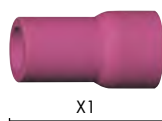

Gas nozzle, ceramic (10 pcs.)		X1	Standard version	
No. 4L	Ø 6.5 mm	29.0 mm	701.0471/53N28	-
No. 6L	Ø 9.5 mm	29.0 mm	701.0472/53N26	-
No. 4L	Ø 6.5 mm	62.5 mm	701.0473/53N24L	-
No. 5L	Ø 8.0 mm	91.5 mm	701.0474/53N27L	-

TIG WELDING TORCHES **ABITIG® GRIP**

ABITIG® GRIP 12-1



All documents in
one place: ABIDOC



ABITIG® GRIP 12-1

**250-
350 A**



ABITIG® GRIP 12-1

Rating: 350 A DC
250 A AC
Duty cycle: 100%
Tungsten electrodes Ø: 1.6-4.0 mm

Description		Torch body	
Type	Cooling	Version	Part-No.
ABITIG® GRIP 12-1	liquid cooled	Standard - 55.0 mm	712.0020

Technical data according to EN 60 974-7

Due to the different connection variants on the machine side, it is not possible to list part numbers for complete torches. Please contact our sales department.

Wear parts



Back cap (10 pcs.)	Short	Long
	712.0053	712.0051



Collet (10 pcs.)	Standard version
Ø 1.6 mm	712.0062
Ø 2.4 mm	712.0063
Ø 3.2 mm	712.0064
Ø 4.0 mm	712.0065

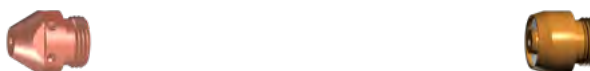

Collet body (10 pcs.)	Standard version	Standard version with gas lens
Ø 1.6 mm	712.0072	712.0101
Ø 2.4 mm	712.0073	712.0102
Ø 3.2 mm	712.0074	712.0103
Ø 4.0 mm	712.0075	712.0104

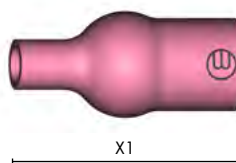

Gas nozzle, ceramic (10 pcs.)		X1	Standard version
No. 4	Ø 6.5 mm	43 mm	704.0046 / 130.00
No. 5	Ø 8.0 mm	43 mm	704.0047 / 131.00
No. 6	Ø 9.5 mm	43 mm	704.0048 / 132.00
No. 7	Ø 11.0 mm	43 mm	704.0049 / 133.00
No. 8	Ø 12.5 mm	43 mm	704.0050 / 134.00
No. 9	Ø 14.5 mm	43 mm	704.0051 / 135.00
No. 10	Ø 16.0 mm	43 mm	704.0052 / 136.00

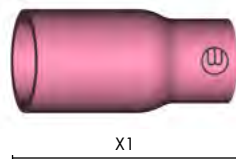

Gas nozzle, ceramic (10 pcs.)		X1	Standard version
No. 11	Ø 17.5 mm	48 mm	704.0053 / 137.00

TIG WELDING TORCHES **ABITIG® GRIP**

ABITIG® GRIP 18 SC

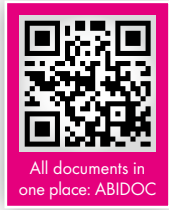

ABITIG® GRIP 18 SC

The SC version (SC = Super Cooled) has a red hose coupling.

280-400 A



ABITIG® GRIP 18 SC

Rating: 400 A DC
280 A AC
Duty cycle: 100%
Tungsten electrodes Ø: 0.5-4.8 mm

Description		Torch body	
Type	Cooling	Version	Part-No.
ABITIG® GRIP 18 SC	liquid cooled	Standard - 75.0 mm	712.6020

Technical data according to EN 60 974-7

Due to the different connection variants on the machine side, it is not possible to list part numbers for complete torches. Please contact our sales department.

Wear parts



Back cap (10 pcs.)	Short	Long
	712.1053	712.1051

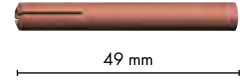
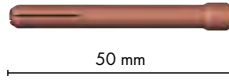

Collet (10 pcs.)	Standard version	HL version*
Ø 0.5 mm	702.0005 / 10N21	-
Ø 1.0 mm	702.0006 / 10N22	-
Ø 1.6 mm	702.0008 / 10N23	-
Ø 2.4 mm	702.0009 / 10N24	-
Ø 3.2 mm	702.0010 / 10N25	712.6064 / 10N25HD
Ø 4.0 mm	-	712.6065 / 54N20HD



Insulating ring (5 pcs.)	Insulating ring 712.6043 / 18NG
--------------------------	------------------------------------



Collet body (10 pcs.)	Standard version	Standard version with gas lens	HL version*
Ø 0.5 mm	-	712.6099 / 18GL02	-
Ø 1.0 mm	-	712.6100 / 18GL04	-
Ø 1.6 mm	-	712.6101 / 18GL16	-
Ø 2.4 mm	-	712.6102 / 18GL32	-
Ø 3.2 mm	-	712.6103 / 18GL18	-
Ø 4.0 mm	-	712.6104 / 18GL53	-
Ø 4.8 mm	-	712.6105 / 18GL36	-
Ø 0.5-3.2 mm	712.6074 / NCB-53	-	-

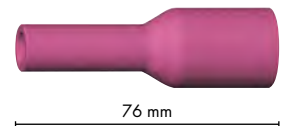
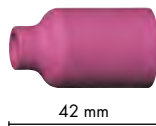

Gas nozzle, ceramic (10 pcs.)		Standard version	Standard version
No. 4	Ø 6.5 mm	701.0420 / 54N18	-
No. 5	Ø 8.0 mm	701.0421 / 54N17	701.0427 / 54N17L
No. 6	Ø 9.5 mm	701.0422 / 54N16	701.0428 / 54N16L
No. 7	Ø 11.0 mm	701.0423 / 54N15	701.0429 / 54N15L
No. 8	Ø 12.5 mm	701.0424 / 54N14	-
No. 12	Ø 19.5 mm	701.0426 / 54N19	-

*Please note: HL = Heavy duty version

TIG WELDING TORCHES **ABITIG® GRIP LITTLE**

ABITIG® GRIP LITTLE 9/9 F ■ **ABITIG® GRIP LITTLE 20**

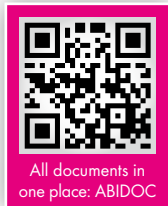

ABITIG® GRIP LITTLE 9

ABITIG® GRIP LITTLE 20

**Special wear parts
see page 156**

**80-
220 A**



ABITIG® GRIP Little 9

Rating: 110 A DC
80 A AC
Duty cycle: 35%
Tungsten electrodes Ø: 0.5-1.6 mm



ABITIG® GRIP Little 20

Rating: 220 A DC
150 A AC
Duty cycle: 100%
Tungsten electrodes Ø: 0.5-3.2 mm

Description		Torch body	
Type	Cooling	Version	Part-No.
ABITIG® GRIP Little 9	gas cooled	Standard - 46.0 mm	705.0001
ABITIG® GRIP Little 9 F	gas cooled	Flexible - 46.0 mm	703.0001
ABITIG® GRIP Little 20	liquid cooled	Standard - 46.0 mm	705.0058

Technical data according to EN 60 974-7

Due to the different connection variants on the machine side, it is not possible to list part numbers for complete torches. Please contact our sales department.

Wear parts



Back cap (10 pcs.)	Short	Medium	Long
	701.0240 / 41V33	701.0244 / 41V35	701.0247 / 41V24

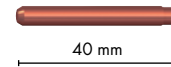
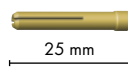
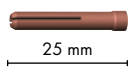

Collet (10 pcs.)	Standard version	Brass version	Jumbo version
Ø 0.5 mm	701.0249 / 13N20	701.1060	701.1225 / 13N20L
Ø 1.0 mm	701.0250 / 13N21	701.1061	701.1226 / 13N21L
Ø 1.2 mm	701.0254 / -	-	-
Ø 1.6 mm	701.0251 / 13N22	701.1019	701.1227 / 13N22L
Ø 2.0 mm	701.0255 / -	-	-
Ø 2.4 mm	701.0252 / 13N23	701.1020	701.1228 / 13N23L
Ø 3.2 mm	701.0253 / 13N24	701.1063	701.1229 / 13N24L



Insulating ring/Adaptor	Insulating ring (10 pcs.)	Adaptor (5 pcs.)
	702.0055 / 598882	701.1234 / 54N63-20



Collet body (10 pcs.)	Standard version	Standard version with gas lens	Jumbo version with gas lens
Ø 0.5- 1.0 mm	701.0275 / 13N26	701.0301 / 45V42	701.1230 / 45V0204S
Ø 1.2 mm	701.0279 / -	701.0313 / -	-
Ø 1.6 mm	701.0276 / 13N27	701.0307 / 45V43	701.1231 / 45V116S
Ø 2.0 mm	701.0280 / -	701.0315 / -	-
Ø 2.4 mm	701.0277 / 13N28	701.0309 / 45V44	701.1232 / 45V64S
Ø 3.2 mm	701.0278 / 13N29	701.0311 / 45V45	701.1233 / 995795S

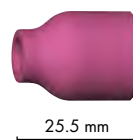

Gas nozzle, ceramic (10 pcs.)		Standard version	Standard version with gas lens	Jumbo version with gas lens
No. 4	Ø 6.5 mm	701.0281 / 13N08	701.0317 / 53N58	-
No. 5	Ø 8.0 mm	701.0282 / 13N09	701.0318 / 53N59	-
No. 6	Ø 9.5 mm	701.0283 / 13N10	701.0319 / 53N60	701.1199 / 57N75
No. 7	Ø 11.0 mm	701.0284 / 13N11	701.0320 / 53N61	-
No. 8	Ø 12.5 mm	701.0285 / 13N12	701.0322 / 53N61S	701.1200 / 57N74
No. 10	Ø 16.0 mm	701.0286 / 13N13	-	701.1201 / 53N88
No. 12	-	-	-	701.1121 / 53N87

Gas nozzle, ceramic (10 pcs.)			X1	Standard version	Jumbo version for gas lens*
 X1	No. 4	Ø 6.5 mm	48 mm	701.0289 / 796F71	-
	No. 5	Ø 8.0 mm	48 mm	701.0290 / 796F72	-
	No. 6	Ø 9.5 mm	48 mm	701.0291 / 796F73	-
 JUMBO 34 mm	No. 4	Ø 6.5 mm	63 mm	701.0293 / 796F75	-
	No. 5	Ø 8.0 mm	63 mm	701.0294 / 796F76	-
	No. 4	Ø 9.5 mm	89 mm	701.0296 / 796F79	-
	-	-	-	-	701.1202 / 53N89

*not suitable for high frequency

TIG WELDING TORCHES **ABITIG® GRIP LITTLE**

ABITIG® GRIP LITTLE 17/17 F/17 V

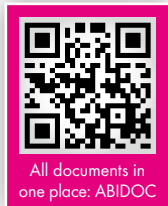

ABITIG® GRIP LITTLE 17

Further wear parts
see page 157

100-
140 A



ABITIG® GRIP Little 17

Rating: 140 A DC
100 A AC
Duty cycle: 35%
Tungsten electrodes Ø: 0.5-2.4 mm

Description		Torch body	
Type		Version	Part-No.
ABITIG® GRIP Little 17	gas cooled	Standard - 65.0 mm	705.0033
ABITIG® GRIP Little 17 F	gas cooled	Flexible - 62.0 mm	703.0009
ABITIG® GRIP Little 17 V	gas cooled	Valve - 64.0 mm	705.0038

Technical data according to EN 60 974-7

Due to the different connection variants on the machine side, it is not possible to list part numbers for complete torches. Please contact our sales department.

Wear parts



Back cap (10 pcs.)	Short	Long
	712.1053	712.1051



Collet (10 pcs.)	Version 50 mm	Version 52 mm
Ø 0.5 mm	702.0005 / 10N21	701.0169 / 10N21D
Ø 1.0 mm	702.0006 / 10N22	701.0171 / 10N22D
Ø 1.2 mm	702.0007 / -	701.0170 / -
Ø 1.6 mm	702.0008 / 10N23	701.0172 / 10N23D
Ø 2.0 mm	702.0012 / -	701.0176 / -
Ø 2.4 mm	702.0009 / 10N24	701.0173 / 10N24D
Ø 3.2 mm	702.0010 / 10N25	701.0174 / 10N25D
Ø 4.0 mm	702.0011 / 54N20	701.0175 / 54N20D



Insulating ring / Adaptor	Insulating ring (10 pcs.)	Adaptor (10 pcs.)	Adaptor (5 pcs.)
	703.0012 / 18CG	701.0130 / 54N01	701.1122 / 54N63

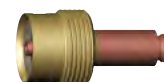
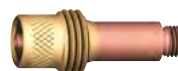

Collet body (10 pcs.)	Standard version	Standard version with gas lens	JumboVersion with gas lens
Ø 0.5-1.2 mm	701.0190 / 10N30	701.0201 / 45V24	-
Ø 1.6 mm	701.0191 / 10N31	701.0203 / 45V25	701.1116 / 45V116
Ø 2.0 mm	701.0196 / 10N32	701.0207 / 45V26	-
Ø 2.4 mm	701.0196 / 10N32	701.0207 / 45V26	701.1117 / 45V64
Ø 3.2 mm	701.0197 / 10N28	701.0209 / 45V27	701.1118 / 995795
Ø 4.0 mm	701.0198 / 406488	701.0211 / 45V28	701.1208 / 45V63



Gas nozzle, ceramic (10 pcs.)		Standard version	Standard version for gas lens	Jumbo version for gas lens
No. 4	Ø 6.5 mm	701.0107 / 10N50	701.0420 / 54N18	-
No. 5	Ø 8.0 mm	701.0108 / 10N49	701.0421 / 54N17	-
No. 6	Ø 9.5 mm	701.0109 / 10N48	701.0422 / 54N16	701.1199 / 57N75
No. 7	Ø 11.0 mm	701.0110 / 10N47	701.0423 / 54N15	-
No. 8	Ø 12.5 mm	701.0111 / 10N46	701.0424 / 54N14	701.1200 / 57N74
No. 10	Ø 16.0 mm	701.0113 / 10N45	-	701.1201 / 53N88
No. 12	Ø 19.5 mm	701.0114 / 10N44*	701.0426 / 54N19	701.1121 / 53N87



Gas nozzle, ceramic (10 pcs.)		Standard version	Standard version for gas lens	Jumbo version for gas lens
No. 5	Ø 8.0 mm	701.0115 / 10N49L	701.0427 / 54N17L	-
No. 6	Ø 9.5 mm	701.0116 / 10N48L	701.0428 / 54N16L	-
No. 7	Ø 11.0 mm	701.0117 / 10N47L	701.0429 / 54N15L	-
	Ø 24.0 mm	-	-	701.1202 / 53N89

*Length 50 mm ■ **not suitable for high frequency

TIG WELDING TORCHES **ABITIG® GRIP LITTLE**

ABITIG® GRIP LITTLE 24 G ■ **ABITIG® GRIP LITTLE 24 W**



All documents in one place: ABIDOC



ABITIG® GRIP LITTLE 24 G

ABITIG® GRIP LITTLE 24 W

80-140 A

* Torch input pressure: min. 2.5 bar (max. 3.5 bar);
Min. flow rate: 0.7 l/min. Technical data based on
cable assembly lengths of up to 8.00 m



ABITIG® GRIP Little 24 G

Rating: 110 A DC
80 A AC
Duty cycle: 35%
Tungsten electrodes Ø: 0.5-1.6 mm



ABITIG® GRIP Little 24 W

Rating: 140 A DC
100 A AC
Duty cycle: 100%
Tungsten electrodes Ø: 0.5-2.4 mm

Description		Torch body	
Type	Cooling	Version	Part-No.
ABITIG® GRIP Little 24 G	gas cooled	Standard - 55.0 mm	705.0075
ABITIG® GRIP Little 24 W	liquid cooled	Standard - 55.0 mm	705.0080

Technical data according to EN 60 974-7

Due to the different connection variants on the machine side, it is not possible to list part numbers for complete torches. Please contact our sales department.

Wear parts



Insulator sleeve / Insulator (10 pcs.)	Insulator sleeve	Insulator for gas lens
	701.0458 / 53N22	701.0459 / 53N66

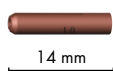

Collet (10 pcs.)	Standard	Standard for gas lens
Ø 0.5 mm	-	-
Ø 1.0 mm	701.0453 / 53N16	701.0462 / 53N63
Ø 1.2 mm	701.0455 / -	-
Ø 1.6 mm	701.0454 / 53N14	701.0463 / 53N64
Ø 2.0 mm	701.0456 / -	701.0466 / -
Ø 2.4 mm	701.0457 / 24C332	701.0465 / 24GLC332



Collet body (10 pcs.)	Standard	Standard with gas lens
Ø 0.5 mm	701.0479 / 53N17	701.0301 / 45V41
Ø 1.0 mm	701.0480 / 53N18	701.0301 / 45V42
Ø 1.2 mm	701.0483 / -	701.0313 / -
Ø 1.6 mm	701.0481 / 53N19	701.0307 / 45V43
Ø 2.0 mm	701.0484 / -	701.0315 / -
Ø 2.4 mm	701.0482 / 24CB332	701.0309 / 45V44

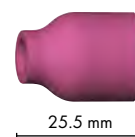

Gas nozzle, ceramic (10 pcs.)			Standard	Standard for gas lens
No. 4	Ø 6.5 mm		701.0468 / 53N24	701.0317 / 53N58
No. 5	Ø 8.0 mm		701.0469 / 53N25	701.0318 / 53N59
No. 6	Ø 9.5 mm		701.0470 / 53N27	701.0319 / 53N60
No. 7	Ø 11.0 mm		-	701.0320 / 53N61

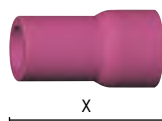

Gas nozzle, ceramic (10 pcs.)		X	Standard	
No. 4L	Ø 6.5 mm	29.0 mm	701.0471 / 53N28	-
No. 6L	Ø 9.5 mm	29.0 mm	701.0472 / 53N26	-
No. 4L	Ø 6.5 mm	62.5 mm	701.0473 / 53N24L	-
No. 5L	Ø 8.0 mm	91.5 mm	701.0474 / 53N27L	-

TIG WELDING TORCHES **ABITIG**[®] WITH ROTARY VALVE

ABITIG[®] 9 V / FV ■ **ABITIG**[®] 17 V / FV ■ **ABITIG**[®] 26 V / FV



ABITIG[®] 9 V / FV

ABITIG[®] 26 V / FV

80-
180 A

Further wear parts
see page 157



ABITIG[®] 9 V / FV

Rating: 110 A DC
80 A AC
Duty cycle: 35%
Tungsten electrodes Ø: 0.5-1.6 mm



ABITIG[®] 17 V / FV

Rating: 140 A DC
100 A AC
Duty cycle: 35%
Tungsten electrodes Ø: 0.5-2.4 mm



ABITIG[®] 26 V / FV

Rating: 180 A DC
130 A AC
Duty cycle: 35%
Tungsten electrodes Ø: 0.5-4.0 mm

Description		Part-No.		Torch body	
Type	Version	4 m	8 m	Type	Part-No.
ABITIG [®] 9 V	Rotary valve / Plug 10-25	706.5057	706.5058	Standard - 60.0 mm	705.0007
ABITIG [®] 9 FV	Rotary valve / Plug 10-25	on demand	on demand	Flexible - 78.0 mm	703.0311.1
ABITIG [®] 17 V	Rotary valve / Plug 10-25	706.1057	706.1058	Standard - 65.0 mm	705.0038
ABITIG [®] 17 V	Rotary valve / Plug 35-50	706.1037	706.1038	Standard - 65.0 mm	705.0038
ABITIG [®] 17 FV	Rotary valve / Plug 10-25	706.1157	706.1158	Flexible - 80.0 mm	703.0010
ABITIG [®] 17 FV	Rotary valve / Plug 35-50	706.1137	706.1138	Flexible - 80.0 mm	703.0010
ABITIG [®] 26 V	Rotary valve / Plug 35-50	706.4037	706.4038	Standard - 80.0 mm	705.0091
ABITIG [®] 26 FV	Rotary valve / Plug 35-50	706.4137	706.4138	Flexible - 80.0 mm	703.0290

Technical data according to 60 974-7

Due to the different connection variants on the machine side, it is not possible to list part numbers for complete torches. Please contact our sales department.

NOTES

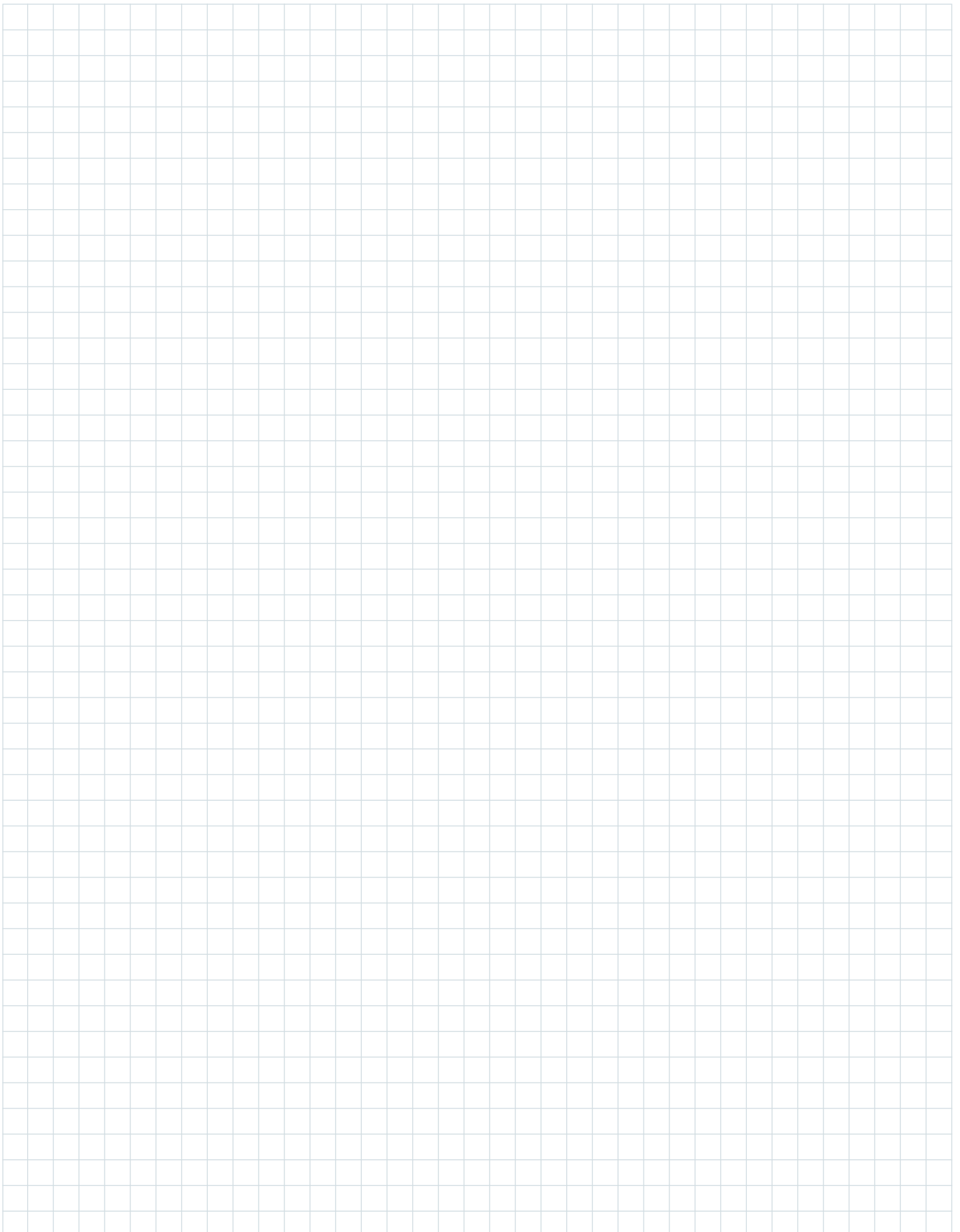

TUNGSTEN ELECTRODES

E3® PRO*

The new generation

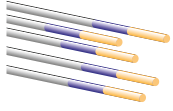

When precision, reliability, and safety are key factors in TIG welding, the 100 % thorium-free E3® PRO tungsten electrode is your first choice. The E3® PRO is the consistent refinement of the proven E3® – with an innovative, unique composition. The result: even more power, longer service life, and universal application possibilities.

Perfect ignition – every time: Easiest ignition, even in the low amp range – for clean starts without compromise.

Maximum service life: Longer service life means fewer electrode changes and greater productivity.

Unlimited applications: Whether manual or automated welding, AC or DC – the E3® PRO covers all applications and materials.

High-tech inside: The innovative manufacturing process, combined with the unique composition of rare earth oxides, produces an extremely fine, homogeneous structure and guarantees outstanding welding properties.

E3®*

The all-rounder

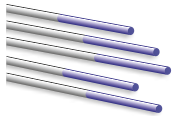

The environmentally friendly E3®, made from rare earths and proven over many years, is the tried-and-tested all-rounder among tungsten electrodes. Only the E3® PRO further optimizes its unique properties.

Excellent ignition: Its absolutely reliable ignition behavior and stable arc make the E3® interesting for automated processes as well.

Long service life: The consistently low electrode temperature increases the current carrying capacity and thus its service life.

Wide range of applications: Suitable for both DC and AC welding and for practically any metal.

WLa 10/15/20

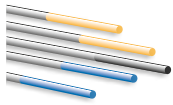

Good ignition properties and service life: The higher the lanthanum content (WLa 20), the better the ignition properties. Their composition enables long service life.

Wide range of applications: Mainly used for welding unalloyed and high-alloy steels, aluminum, titanium, copper, and magnesium alloys. Also suitable for micro plasma welding.

WCe 20



TIG electrode for medium and low current ranges: Its good ignition and reignition properties, as well as its good arc stability, make it ideal for thin sheet welding.

Areas of application with DC applications: Unalloyed and high-alloy steels, as well as nickel, copper, titanium, and aluminum alloys.

WP

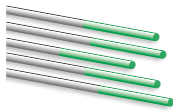

High stability and melting point: The ideal electrode for alternating current welding with a high melting point and therefore good corrosion resistance. Not suitable for DC applications.

Special areas of application: Recommended for light metals such as aluminum, magnesium, and their alloys. In contrast to tungsten electrodes with doping elements, ignition and service life are lower.

WZr 08



Clean weld pool: The zirconium oxide contained in the product forms a stable dome and ensures that the molten bath is not contaminated.

Ideal for AC applications: Aluminum, magnesium, nickel, and their alloys are the main areas of application. It has poor ignition properties in DC welding.

*According to DIN EN ISO 6848

Tungsten electrodes per DIN EN ISO 6848

Characteristics	E3® PRO gold-purple		E3® purple		WLa 10 black		WLa 15 gold		WLa 20 blue		WCe 20 grey		WP green		WZr 08 white	
	+++	+++	+++	+++	+	+	++	++	+++	+++	+	+	+	+	-	-
Direct current minus pole	+++	+++	+++	+++	+	+	++	++	+++	+++	+	+	+	-	-	-
Alternating current	+++	+++	+++	+++	-	-	+	+	+	+	+	+	+	+	++	++
Arc stability	+++	+++	++	++	+	+	+	+	+++	+++	+	+	+	-	++	++
Ignitability	++++	++++	++++	++++	+	+	++	++	+++	+++	+	+	+	-	+	+
Lifetime	++++	++++	++++	++++	+	+	++	++	+++	+++	+	+	+	+	++	++
High alloy steels weldable	+++	+++	+++	+++	+	+	+++	+++	+++	+++	+++	+++	+++	-	-	-
Aluminum weldable	+++	+++	+++	+++	+	+	+	+	+	+	+	+	++	++	++	++

Length: 75 mm (10 pcs.)

Ø 1.0 mm	-	-	-	-	-	-	-	-	-	-	-	-	-	-	-	-
Ø 1.6 mm	-	-	700.0314.10	-	-	-	-	-	-	-	-	-	-	-	-	-
Ø 2.0 mm	-	-	-	-	-	-	-	-	-	-	-	-	-	-	-	-
Ø 2.4 mm	-	-	700.0316.10	-	-	-	-	-	-	-	700.0218.10	-	-	-	-	-
Ø 3.2 mm	-	-	700.0317.10	-	-	-	-	-	-	-	-	-	-	-	-	-
Ø 4.0 mm	-	-	-	-	-	-	-	-	-	-	-	-	-	-	-	-

Length: 150 mm (10 pcs.)

Ø 1.0 mm	700.0371.10	700.0295.10	-	-	-	-	-	-	-	-	-	-	-	-	-	-
Ø 1.6 mm	700.0363.10	700.0297.10	-	-	-	-	-	-	700.0229.10	700.0176.10	700.0006.10	700.0029.10	-	-	-	-
Ø 2.0 mm	700.0372.10	700.0298.10	-	-	-	-	-	-	700.0286.10	700.0181.10	700.0008.10	-	-	-	-	-
Ø 2.4 mm	700.0364.10	700.0299.10	-	-	-	-	-	700.0280.10	700.0230.10	700.0175.10	700.0011.10	700.0033.10	-	-	-	-
Ø 3.2 mm	700.0365.10	700.0301.10	-	-	-	-	-	-	700.0231.10	-	700.0015.10	-	-	-	-	-
Ø 4.0 mm	700.0374.10	700.0302.10	-	-	-	-	-	-	-	-	700.0017.10	-	-	-	-	-

Length: 175 mm (10 pcs.)

Ø 1.0 mm	700.0367.10	700.0304.10	700.0157.10	700.1183.10	700.0219.10	700.0166.10	700.0003.10	700.0028.10
Ø 1.6 mm	700.0360.10	700.0306.10	700.0158.10	700.1184.10	700.0220.10	700.0167.10	700.0007.10	700.0030.10
Ø 2.0 mm	700.0366.10	700.0307.10	700.0159.10	700.1185.10	700.0221.10	700.0168.10	700.0009.10	700.0032.10
Ø 2.4 mm	700.0361.10	700.0308.10	700.0160.10	700.1186.10	700.0222.10	700.0169.10	700.0012.10	700.0034.10
Ø 3.2 mm	700.0362.10	700.0310.10	700.0162.10	700.1187.10	700.0223.10	700.0170.10	700.0016.10	700.0036.10
Ø 4.0 mm	700.0369.10	700.0311.10	700.0163.10	700.0255.10	700.0242.10	700.0171.10	700.0018.10	700.0037.10

WIRE FEEDER SYSTEM **ABIDRIVE V2**

Precise wire feed for excellent weld seam results

The robust and reliable wire feeder ensures continuous and high-precision wire feeding with its high-quality 4-roller drive. This guarantees the best welding results and maximum efficiency.

This wire feeder can be used for manual welding with cold wire feed as well as for automated welding with ABICOR BINZEL machine torches. Due to the intuitive control panel, the device is extremely user-friendly. Thanks to freely configurable interconnection cables, the ABIDRIVE V2 can be used with all common power sources. A hot wire option is also available.

The advantages of the reliable and robust ABIDRIVE V2 at a glance:

- Wire speed adjustable from 0.2 to 0.8 m/min
- The speed can be finely adjusted in steps of 0.02 m/min
- Two driven wire feed rollers for minimal slippage and maximum feed consistency
- Customizable interconnection cable assemblies
- Can be integrated into hot wire systems
- Customizable wire retraction
- Finely adjustable interval function for defining the seam shape and appearance
- 2- or 4-cycle operation
- Optional remote controls (potentiometer or up/down) for automated TIG welding
- Commercially available standard connections/quick couplings



Technical data

ABIDRIVE V2 (230 V)

Inlet voltage:	230 V/50 Hz \pm 10%
Welding current:	300 A (100% duty cycle and direct connection)
Delay fuse:	2 AT
Wire speed:	0.2–8.0 m/min
Wire diameter:	0.8–1.6 mm
Protection class:	IP21s
Weight:	17 kg
Size (L/W/H):	674 x 260 x 408 mm

ABIDRIVE V2 (115 V)

Inlet voltage:	115 V/50 Hz \pm 10%
Welding current:	300 A (100% duty cycle and direct connection)
Delay fuse:	2 AT
Wire speed:	0.2–8.0 m/min
Wire diameter:	0.8–1.6 mm
Protection class:	IP21s
Weight:	17 kg
Size (L/W/H):	674 x 260 x 408 mm

Technical data according to EN 60 974-7

**System overview
direct connection
ABIDRIVE V2**

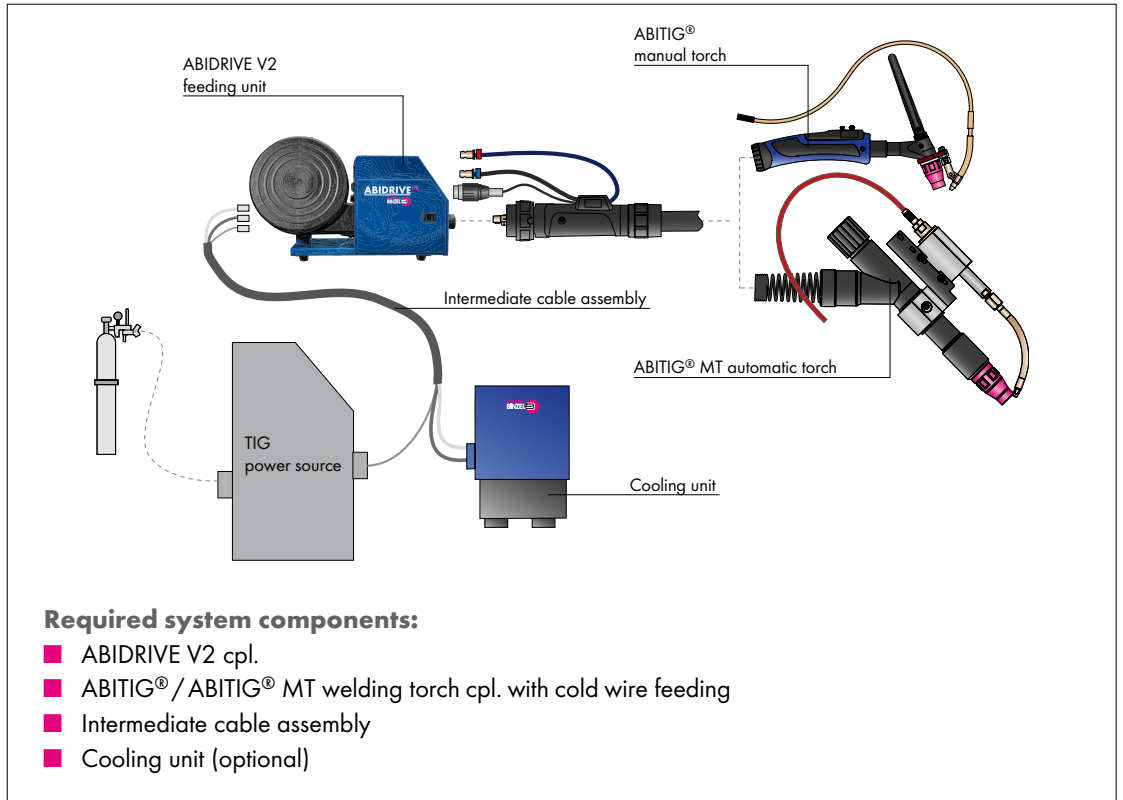

**System overview
direct connection
power source**

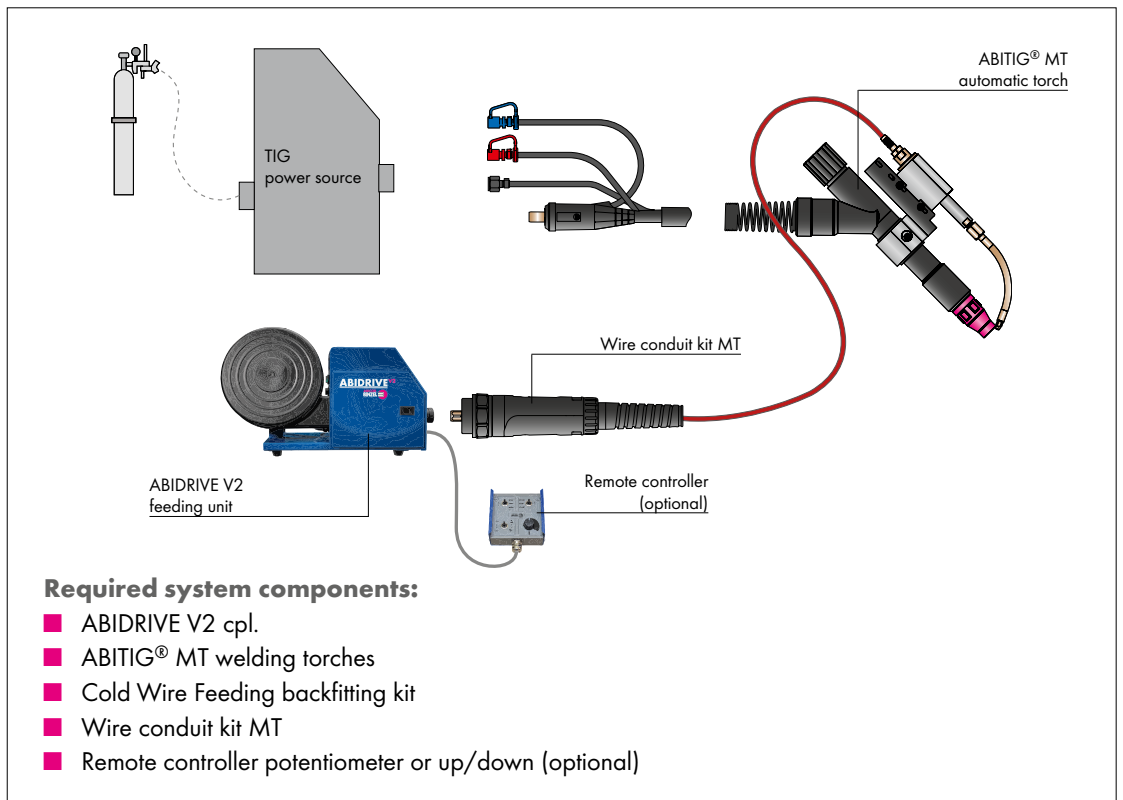

WIRE FEEDER SYSTEM **ABIDRIVE V2**

ABIDRIVE V2 cpl.



Wire Feeder System ABIDRIVE V2		
Description	Details	Part-No.
Wire Feeder System ABIDRIVE V2 (without wire feed rolls)	230 V	525.2002.1
Wire Feeder System ABIDRIVE V2 (without wire feed rolls)	115 V	525.2003.1

Drive rolls

Drive rolls (1 pc.)		
Description	Details	Part-No.
Wire feed roll 1.0 cpl.	4x U-groove driven	525.2053.1
Wire feed roll 1.2 cpl.	4x U-groove driven	525.2004.1
Wire feed roll 1.6 cpl.	4x U-groove driven	525.2005.1
Wire feed roll 0.8 cpl.	2x V-groove / 2x smooth	525.2008.1
Wire feed roll 1.0 cpl.	2x V-groove / 2x smooth	525.2009.1
Wire feed roll 1.2 cpl.	2x V-groove / 2x smooth	525.2010.1
Wire feed roll 1.6 cpl.	2x V-groove / 2x smooth	525.2011.1
Wire feed roll 0.8 cpl.	2x V-groove / 2x smooth driven	525.2012.1
Wire feed roll 1.0 cpl.	2x V-groove / 2x smooth driven	525.2013.1
Wire feed roll 1.2 cpl.	2x V-groove / 2x smooth driven	525.2014.1
Wire feed roll 1.6 cpl.	2x V-groove / 2x smooth driven	525.2015.1
Wire feed roll 0.8	2x V-groove w/o pressure roll	525.2049.1
Wire feed roll 1.0	2x V-groove w/o pressure roll	525.2050.1
Wire feed roll 1.2	2x V-groove w/o pressure roll	525.2051.1
Wire feed roll 1.6	2x V-groove w/o pressure roll	525.2052.1

Options / Spare parts

Options / Spare parts		
Description	Details	Part-No.
Remote control V2	Up/Down	525.2042.1
Remote control V2	Potentiometer	525.2043.1
Drive gear	Plastics	525.2044.1

Intermediate cable assembly

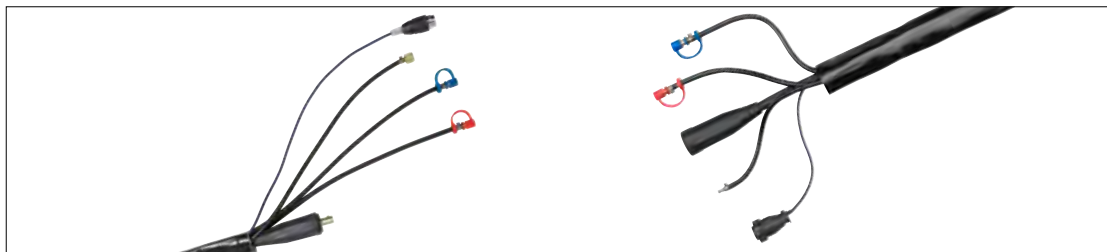

TIG intermediate cable assembly (L=2.00 m) ▪ gas cooled						
Current	Control cable	Inert gas	Coolant		Details	Part-No.
			Inlet	Return		
BCS-11 BLS-46B BHC-00	Amphenol 7 pol.	G1/4" IG	-	-	Kemppi®	525.2022.1
BCS-06 BLS-15A BHC-00	Tuchel 9 pol.	G3/8" IG	-	-	Fronius®	525.2024.1
Plug 50-70 BLS-01B BHC-05	Tuchel 5 pol.	ND 2.7 mm	-	-	Lorch®	525.2056.1

TIG intermediate cable assembly (L=2.00 m) ▪ liquid cooled						
Current	Control cable	Inert gas	Coolant		Details	Part-No.
			Inlet	Return		
Plug 50-70 BLS-37 BHC-11	Burndy 8 pol.	G1/4" IG	ND 5 mm	ND 5 mm	EWM®	525.2017.1
Plug 50-70 BLS-01A BHC-11	Tuchel 5 pol.	G1/4" IG	ND 5 mm	ND 5 mm	EWM®	525.2018.1
Plug 50-70 BLS-01B BHC-16	Tuchel 5 pol.	ND 2.7 mm	ND 5 mm	ND 5 mm	Lorch®	525.2019.1
Plug 50-70 BLS-03A BHC-16	Circular connector 7 pol.	ND 2.7 mm	ND 5 mm	ND 5 mm	Rehm®	525.2020.1
BCS-11 BLS-46B BHC-12	Amphenol 7 pol.	G1/4" IG	ND 5 mm	ND 5 mm	Kemppi®	525.2021.1
BCS-03 BLS-01A BHC-12	Tuchel 5 pol.	WZ-0	ND 5 mm	ND 5 mm	Merkle®	525.2023.1
Plug 50-70 BLS-01B BHC-11	Tuchel 5 pol.	G1/4" IG	ND 5 mm	ND 5 mm	Jäckle®/ Lorch®	525.2025.1
BCS-36 BLS-15A BHC-12	Tuchel 9 pol.	central Fronius-ZA	ND 5 mm	ND 5 mm	Fronius®	525.2026.1
BCS-06 BLS-10A BHC-15	Amphenol 4 pol.	G1/4" IG	G3/8" IG	G3/8" IG	Kemppi®	525.2027.1
Plug 50-70 BLS-09A BHC-21	Amphenol 2 pol.	G1/8" IG	ND 5 mm	ND 5 mm	ESAB®	525.2028.1
BCS-19 BLS-04A BHC-00	Tuchel 5 pol.	central Oerlikon-ZA	Zentral	Zentral	Oerlikon®	525.2029.1
BCS-25 BLS-04A BHC-12	Tuchel 5 pol.	central Oerlikon BSB	ND 5 mm	ND 5 mm	Oerlikon®	525.2030.1
BCS-07 BLS-99A BHC-12		ZA 9 pol.	ND 5 mm	ND 5 mm	Esab®/ Selco®	525.2031.1
Plug 50-70 BLS-01B BHC-30	Tuchel 5 pol.	G1/4" IG	G3/8" IG	M12x1	ESS®	525.2032.1
BCS-37 BLS-01A BHC-12	Tuchel 5 pol.	Merkle TCG	ND 5 mm	ND 5 mm	Merkle®	525.2033.1
Plug 50-70 BLS-01B BHC-26	Tuchel 5 pol.	G3/8" IG	ND 5 mm	ND 5 mm	Cloos®	525.2036.1
Plug 50-70 BLS-64B BHC-20	Amphenol 6 pol.	ND 5 mm	ND 5 mm	ND 5 mm	CEA®	525.2057.1

All trademarks mentioned in this brochure are property of the respective companies.

COMPONENT KITS

Component kits ABITIG® 9 / 17 / 18 / 20 / 20 SC / 26			
Type	Electrode Ø 1.6 mm	Electrode Ø 2.4 mm	Electrode Ø 3.2 mm
ABITIG® 9 (Collet body)	712.3151	-	-
ABITIG® 9 (Gas lens)	712.3191	-	-
ABITIG® 17 (Collet body)	712.2151	712.2152	-
ABITIG® 17 (Gas lens)	-	712.2192	-
ABITIG® 18 (Collet body)	-	712.2152	712.2153
ABITIG® 18 (Gas lens)	-	712.2192	-
ABITIG® 20 (Collet body)	-	712.3152	-
ABITIG® 20 (Gas lens)	-	712.3192	-
ABITIG® 20 SC (Collet body)	-	712.3152	-
ABITIG® 20 SC (Gas lens)	-	712.3192	-
ABITIG® 26 (Collet body)	-	712.2152	712.2153
ABITIG® 26 (Gas lens)	-	712.2192	-

Component kit "Collet body" consisting of: Back cap long, collet, collet body and gas nozzle ceramic.

Component kit "Gas lens" consisting of: Back cap long, collet, collet body with gas lens and gas nozzle ceramic.

Component kits ABITIG® 150 / 260 W / 260 W SC			
Type	Electrode Ø 1.6 mm	Electrode Ø 2.4 mm	Electrode Ø 3.2 mm
ABITIG® 150 (Electrode holder)	777.0182	777.0183	-
ABITIG® 150 (Gas diffuser)	-	777.0193	-
ABITIG® 260 W (Electrode holder)	777.0182	777.0183	-
ABITIG® 260 W (Gas diffuser)	-	777.0193	-
ABITIG® 260 W SC (Electrode holder)	777.0182	777.0183	-
ABITIG® 260 W SC (Gas diffuser)	-	777.0193	-

Component kit "Electrode holder" consisting of: Back cap medium, electrode holder and gas nozzle ceramic.

Component kit "Gas diffuser" consisting of: Back cap medium, gas diffuser and gas nozzle ceramic.

Component kits ABITIG® 200 / 450 W / 450 W SC			
Type	Electrode Ø 2.4 mm	Electrode Ø 3.2 mm	Electrode Ø 4.8 mm
ABITIG® 200 (Electrode holder)	774.0183	-	-
ABITIG® 200 (Gas diffuser)	774.0193	-	-
ABITIG® 450 W (Electrode holder)	774.0183	-	-
ABITIG® 450 W (Gas diffuser)	774.0193	-	-
ABITIG® 450 W SC (Electrode holder)	774.0183	-	-
ABITIG® 450 W SC (Gas diffuser)	774.0193	-	774.0196

Component kit "Electrode holder" consisting of: Back cap long, electrode holder and gas nozzle ceramic.

Component kit "Gas diffuser" consisting of: Back cap long, gas diffuser and gas nozzle ceramic.

POWER CABLES ■ CONTROL CABLES ■ HOSES

Power cables ABITIG® GRIP						
Type	Power cable Standard			Power cable High Flex		
	4 m	8 m	12 m	4 m	8 m	12 m
ABITIG® 9	150.0084	150.0085	150.0086	150.0065	150.0066	150.0067
ABITIG® 20	150.0015	150.0016	150.0017	150.0062	150.0063	150.0064
ABITIG® 20 SC	-	-	-	150.0301.1	150.0302.1	150.0303.1
ABITIG® 17	150.0084	150.0085	150.0086	150.0065	150.0066	150.0067
ABITIG® 18	150.0018	150.0019	150.0020	150.0068	150.0069	150.0070
ABITIG® 18 SC	150.0018	150.0019	150.0020	150.0068	150.0069	150.0070
ABITIG® 26	150.0087	150.0088	150.0089	150.0059	150.0060	150.0061
ABITIG® 24 G	150.0084	150.0085	150.0086	150.0065	150.0066	150.0067
ABITIG® 24 W	150.0015	150.0016	150.0017	150.0062	150.0063	150.0064
ABITIG® 12-1	150.0074	150.0075	150.0076	150.0071	150.0072	150.0073
ABITIG® 150	150.0111	150.0112	150.0113	150.0040	150.0041	150.0190
ABITIG® 260 W	150.0099	150.0100	150.0101	150.0164	150.0165	150.0166
ABITIG® 260 W SC	-	-	-	150.0305.1	150.0306.1	150.0307.1
ABITIG® 200	150.0170	150.0171	150.0172	150.0036	150.0037	150.0114
ABITIG® 450 W	150.0054	150.0055	150.0083	150.0167	150.0168	150.0169
ABITIG® 450 W SC	-	-	-	150.0203	150.0194	150.0204
ABITIG® 500 W	150.0084	150.0085	150.0086	150.0065	150.0066	150.0067

Power cable for TIG welding torches ABITIG® with rotary valve and TIG machine torches on request.

Power cables ABITIG® GRIP Little						
Typ	Power cable Standard			Power cable High Flex		
	4 m	8 m	12 m	4 m	8 m	12 m
ABITIG® 9	150.0084	150.0085	150.0086	150.0065	150.0066	150.0067
ABITIG® 20	150.0259.1	150.0260.1	150.0261.1	150.0255.1	150.0256.1	150.0257.1
ABITIG® 17	150.0084	150.0085	150.0086	150.0065	150.0066	150.0067
ABITIG® 24 G	150.0084	150.0085	150.0086	150.0065	150.0066	150.0067
ABITIG® 24 W	150.0259.1	150.0260.1	150.0261.1	150.0255.1	150.0256.1	150.0257.1
ABITIG® 90	150.0111	150.0112	150.0113	150.0040	150.0041	150.0190
ABITIG® 150	150.0111	150.0112	150.0113	150.0040	150.0041	150.0190
ABITIG® 180 W	150.0267.1	150.0268.1	150.0269.1	150.0002*	150.0003*	150.0272.1
ABITIG® 260 W	150.0267.1	150.0268.1	150.0269.1	150.0002*	150.0003*	150.0272.1

*highly flexible PU version

Control cables			
Type	Description	Details	Part-No.
all torches*	Power cable 3 core	100 m	100.0100
all torches*	Power cable 6 core	100 m	100.0112
all torches*	Power cable 6 core (protected)	100 m	100.0028

*apart from TIG welding torches ABITIG® GRIP with rotary valve and TIG machine torches

POWER CABLES ■ CONTROL CABLES ■ HOSES

Outer hoses			
Type	Description	Details	Part-No.
ABITIG® 9/20	Outer hose 22x1.25 mm	40 m	109.0020
ABITIG® 17/18/18 SC/26			
ABITIG® 24 G/24 W			
ABITIG® 12-1			
ABITIG® 90/180 W			
ABITIG® 150/260 W			
ABITIG® 200/450 W			
ABITIG® 500 W			
ABITIG® 9 V			
ABITIG® 17 V/17 FV			
ABITIG® 20 SC	Outer hose 25x1.25 mm	40 m	105.0019
ABITIG® 260 W SC			
ABITIG® 450 W SC			
ABITIG® 26 V/26 FV			
ABITIG® 150 MT	Outer hose 22x1.25 mm	40 m	109.0020
ABITIG® 200 MT			
ABITIG® 260 W MT			
ABITIG® 300 W MT			
ABITIG® 400 W MT			
ABITIG® 500 W MT			
ABITIG® MT with cold wire feed	Outer hose 25x1.25 mm	40 m	105.0019

Leather hose and hose coupling		
Type	Description	Part-No.
all torches*	Leather hose 0.8 m	108.0028
all torches**	Hose coupling complete for connecting leather and outer hose	400.0391
ABITIG® 20 SC	Hose coupling complete for connecting leather and outer hose	400.0392
ABITIG® 260 W SC		
ABITIG® 450 W SC		
ABITIG® 500 W		

*apart from TIG welding torches ABITIG® GRIP with rotary valve and TIG machine torches

**apart from TIG welding torches ABITIG® GRIP with rotary valve, TIG machine torches and ABITIG® GRIP 20 SC/260 W SC/450 W SC/500 W

Gas hoses			
Type	Description	Details	Part-No.
ABITIG® 20/20 SC	Shielding gas hose 3.5x1.25 mm, PVC	100 m	102.0124
ABITIG® 18/18 SC			
ABITIG® 24 W			
ABITIG® 12-1			
ABITIG® 180 W			
ABITIG® 260 W/260 W SC			
ABITIG® 450 W/450 W SC			
ABITIG® 500 W			
ABITIG® 9 V			
ABITIG® 17 V/17 FV			
ABITIG® 26 V/26 FV	Shielding gas hose 4.9x1.5 mm, PVC	100 m	109.0040
ABITIG® 260 W MT	Shielding gas hose 3.5x1.25 mm, PVC	100 m	102.0124
ABITIG® 300 W MT			
ABITIG® 400 W MT			
ABITIG® 500 W MT			

Spare parts mentioned are suitable for use with all ABITIG®, ABITIG® GRIP and ABITIG® GRIP Little TIG welding torches – unless specifically marked.

Water hose			
Type	Description	Part-No.	
		PVC black per 100 m	BRH per 40 m
ABITIG® 20/20 SC	Water hose 3.9 x 1.5 mm	109.0011	109.0059
ABITIG® 18/18 SC			
ABITIG® 24 W			
ABITIG® 12-1			
ABITIG® 500 W			
ABITIG® 260 W MT			
ABITIG® 300 W MT			
ABITIG® 400 W MT			
ABITIG® 500 W MT			

Hose clamps, marking washers and ceiling covers					
Type	Part-No. (20 pcs.)	for hose			
		102.0124	109.0011	109.0040	109.0059
Hose clamp Ø=9.0 with ring (mark. 9.5)	173.0001			•	•
Hose clamp Ø=8.2 with ring (mark. 8.7)	173.0005		•		
Hose clamp Ø=7.5 with ring (mark. 8.0)	173.0007	•			
Marking washer red	501.2166		•		•
Marking washer blue	501.2167		•		•
Ceiling cover red	501.2423		•		•
Ceiling cover blue	501.2424		•		•

HANDLES ■ MODULES

Handles ABITIG® GRIP and control modules			
Type	Description	Details	Part-No.
all ABITIG® GRIP torches *	Handle ABITIG® GRIP, without control module		180.0130.1
all ABITIG® GRIP torches *	Control module single push-button	BIS-51	400.1275.1
	Control module single push-button with potentiometer 10 kΩ (3 pole)	BIS-59	400.1281.1
	Control module double push-button	BIS-52	400.1276.1
	Control module double push-button for high switching current (up to 2 A)	BIS-60	400.1280.1
	Control module double push-button with potentiometer 1 kΩ	BIS-64	400.1327.1
	Control module double push-button with potentiometer 2.2 kΩ	BIS-74	400.1328.1
	Control module double push-button with potentiometer 4.7 kΩ	BIS-84	400.1329.1
	Control module double push-button with potentiometer 10 kΩ	BIS-54	400.1278.1
	Control module double push-button with potentiometer 47 kΩ	BIS-94	400.1330.1
	Control module double push-button with compensator	BIS-67	400.1282.1
	Control module UP/DOWN (device-dependent)	BIS-65	400.1279.1
	Control module UP/DOWN (device-dependent)	BIS-66	400.1479.1
	Control module UP/DOWN (compatible with Stel®/CEA®)	BIS-85	400.1367.1
	Control module UP/DOWN (compatible with Lorch®)	BIS-95	400.1277.1
	Control module UP/DOWN	BIS-97	400.1807.1
	Control module single push-button with rubber calotte	BIS-R1	400.1378.1
Control module UP/DOWN (compatible with Migatron®)	BIS-CM	400.2136.1	

*apart from TIG welding torches ABITIG® GRIP with rotary valve and TIG machine torches

Handle ABITIG® GRIP Little and control modules			
Type	Description	Details	Part-No.
all ABITIG® GRIP Little torches *	Handle ABITIG® GRIP Little, without control module		180.0131.1
all ABITIG® GRIP Little torches *	Control module single push-button	BIS-51	400.1296.1
	Control module single push-button (lower release force than BIS-51)	BIS-S1	400.1647.1
	Control module double push-button	BIS-52	400.1292.1
	Control module UP/DOWN (device-dependent)	BIS-55	400.1388.1
	Control module UP/DOWN (device-dependent)	BIS-65	400.1318.1
	Control module UP/DOWN (compatible with Stel®/CEA®)	BIS-85	400.1375.1
	Control module UP/DOWN (compatible with Lorch®)	BIS-95	400.1354.1
	Control module UP/DOWN (compatible with Migatron®)	BIS-CM	400.2137.1
	Lid (5 pcs.)	BIS-57	400.1402.5

*apart from TIG welding torches ABITIG® GRIP with rotary valve and TIG machine torches

ABITIG® GRIP Control module housing for control modules of the series ABITIG® GRIP Little			
Typ	Beschreibung	Details	Part-No.
all ABITIG® GRIP torches *	Control module housing	-	400.1466.1

*apart from TIG welding torches ABITIG® GRIP with rotary valve and TIG machine torches

Handles and rotary valves			
Type	Description		Part-No.
ABITIG® 9 V / 17 V / 17 FV	Handle		705.1440
	Rotary valve		705.0046
ABITIG® 26 V / 26 FV	Handle		705.0096
	Rotary valve		705.0097

Handle with turnable torch neck ABITIG® GRIP			
Type	Description		Part-No.
ABITIG® GRIP Handle with rotatable body	Handle complete (without module)		180.0146.1
ABITIG® GRIP torch	Control module BIS-F1		400.1497.1

All trademarks mentioned in this brochure are the property of the respective companies.

Handle ABITIG® GRIP Little



BIS-51 / BIS-51 (lower release force)
ED = Single push-button



BIS-52
DD = Double push-button/ Button short
(in Torch-Price-List Standard under DD)



BIS-55
UD = UP/DOWN
(device-dependent)



BIS-65 / BIS-CM (for Migatronic®)
UD = UP/DOWN
(device-dependent)



BIS-85
UD = UP/DOWN
(compatible with Stel®/CEA®)



BIS-95
UD = UP/DOWN
(compatible with Lorch®)



BIS-57
Lid (5 pcs.)



Matching handle
Part-No.: 180.0131.1

Handle ABITIG® GRIP (turnable torch neck)



BIS-F1
Control module



Handle for 360° turnable torch neck
Part-No.: 180.0146.1

Abbreviations for switch functions:

- ED Single push-button
- DD Double push-button
- UD UP / DOWN (two switches)
- EDP¹ Single push-button with potentiometer 10 kΩ, other factors on request
(z. B. 1.0 kΩ, 2.2 kΩ, 4.7 kΩ, 47 kΩ)
- DDP* Double push-button with potentiometer 10 kΩ, other factors on request
(z. B. 1.0 kΩ, 2.2 kΩ, 4.7 kΩ, 47 kΩ)

All trademarks mentioned in this brochure are property of the respective companies.

Handle ABITIG® GRIP



BIS-51
ED = Single push-button



BIS-52
DD = Double push-button/
Button long



BIS-54 / -64 / -74 / -84 / -94
DDP = Double push-button/
Poti xx kΩ



BIS-59
EDP = Single push-button/
Poti 10 kΩ (compatible with
Migatronic®, 3 pole)



BIS-60
DD = Double push-button/
Button long for high switching
current up to 2 A



BIS-65 / BIS-CM (for Migatronic®)
UD = UP/DOWN
(device-dependent)



BIS-66
UD = UP/DOWN



BIS-67
DD = Double push-button /
Compensator



BIS-85
UD = UP/DOWN
(compatible with Stel®/CEA®)



BIS-95
UD = UP/DOWN
(compatible with Lorch®)



BIS-97
UD = UP/DOWN



BIS-R1
ED = Single push-button
with rubber calotte



Control module housing
For BIS control modules of ABITIG®
GRIP Little series
Part-No.: 400.1466.1



Matching handle
Part-No.: 180.0130.1

*In the case of potentiometer regulation in the handle, an HF-filter is essential if the potentiometer cable runs through the remote control connector and is started with high voltage pulses. If there is no HF-filter, the HF pulses may damage the control electronics.

Please order the HF-control cable filter DGF 3 by using the Part-No. 184.0162.

ACCESSORIES AND SPECIAL PARTS **TIG**

ABITIG® GRIP LITTLE 25 F ■ **ABITIG® GRIP LITTLE 20 F**

Flexible torch necks, individually adaptable to the welding task.

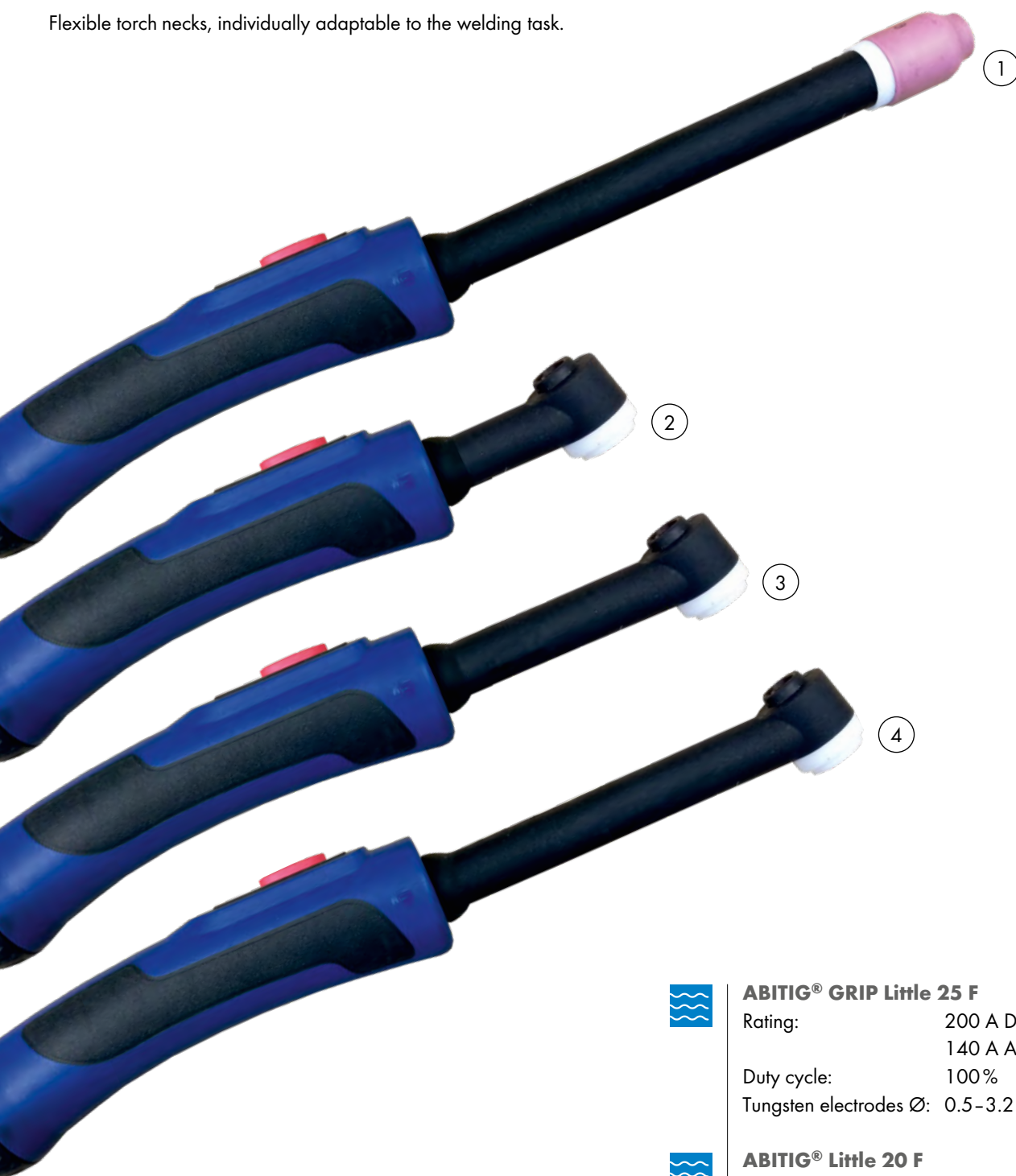

**140-
240 A**



ABITIG® GRIP Little 25 F

Rating: 200 A DC
140 A AC
Duty cycle: 100%
Tungsten electrodes Ø: 0.5-3.2 mm



ABITIG® Little 20 F

Rating: 240 A DC
170 A AC
Duty cycle: 100%
Tungsten electrodes Ø: 0.5-3.2 mm

Pos.	Description	Cooling	Version	Pcs.	Part-No.
1	Torch body ABITIG® GRIP Little 25 F, 135 mm	liquid cooled	Flexible	1	703.0304
2	Torch body ABITIG® GRIP Little 20 F, 45 mm	liquid cooled	Flexible	1	703.0302
3	Torch body ABITIG® GRIP Little 20 F, 75 mm	liquid cooled	Flexible	1	703.0305
4	Torch body ABITIG® GRIP Little 20 F, 110 mm	liquid cooled	Flexible	1	703.0306
-	Adapter socket for use in handle ABITIG® GRIP	-	-	1	712.7026

Technical data according to EN 60 974-7

Due to the different connection variants on the machine side, it is not possible to list part numbers for complete torches. Please contact our sales department.

ACCESSORIES AND SPECIAL PARTS **TIG**

ABITIG® GRIP LITTLE SL 9 ■ ABITIG® GRIP LITTLE SL 17/26

ABITIG® GRIP LITTLE SL 18/20

- Available in gas and liquid cooled versions
- Particularly suitable for components that are difficult to access, e. g. for pipe welding
- 360° rotatable
- Torch head can be replaced

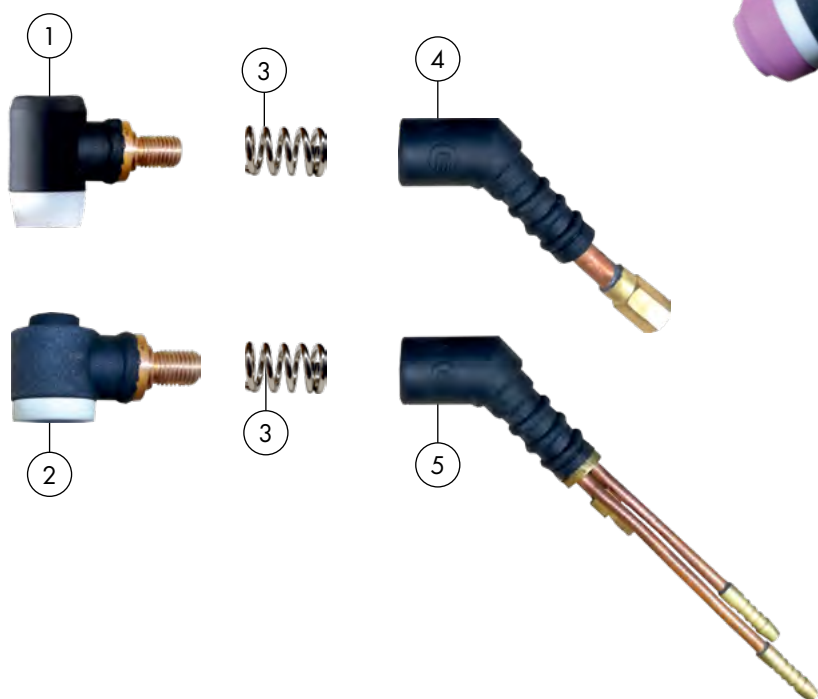

**80 –
180 A**



ABITIG® GRIP Little SL 9

Rating: 110 A DC
80 A AC
Duty cycle: 35%
Tungsten electrodes Ø: 0.5-1.6 mm



ABITIG® GRIP Little SL 17/26

Rating: 150 A DC
105 A AC
Duty cycle: 35%
Tungsten electrodes Ø: 0.5-4.0 mm



ABITIG® GRIP Little SL 18/20

Rating: 180 A DC
130 A AC
Duty cycle: 100%
Tungsten electrodes Ø: 0.5-3.0 mm

Pos.	Description	Cooling	Version	Pcs.	Part-No.
1	Torch head ABITIG® SL 9/17/26	gas cooled	SL	2	705.1787.2
2	Torch head ABITIG® SL 18/20	liquid cooled	SL	2	705.1786.2
3	Spring	-	-	10	705.1788.10
4	Torch body ABITIG® GRIP Little SL*	gas cooled	SL	2	705.1789.2
5	Torch body ABITIG® GRIP Little SL*	liquid cooled	SL	2	705.1790.2

* Can also be used in combination with adapter socket 712.7026 in handle ABITIG GRIP® 180.0130.1.

Technical data according to EN 60 974-7

Due to the different connection variants on the machine side, it is not possible to list part numbers for complete torches. Please contact our sales department.

ACCESSORIES AND SPECIAL PARTS **TIG**

SHORT EQUIPMENT OPTIONS (STUBBY) FOR ABITIG® 9/20

The short dimensions and compact design of the wear parts enable welding in confined spaces.



Equipment option 1

Equipment option 2



Insulating ring (5 pcs.)	Equipment option 1 & 2
	712.7121.5

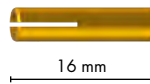

16 mm

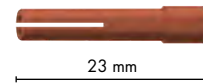

23 mm

Clamping sleeve (10 pcs.)	Equipment option 1	Equipment option 2
Ø 1.0 mm	712.7122.10	712.7201.10
Ø 1.6 mm	712.7123.10	712.7202.10
Ø 2.4 mm	712.7124.10	712.7203.10
Ø 3.2 mm	712.7126.10	712.7204.10



10.0 mm



19.5 mm

Clamping sleeve housing (5 pcs.)	Equipment option 1	Equipment option 2
Ø 1.0 mm	712.7127.5	712.7205.5
Ø 1.6 mm	712.7128.5	712.7206.5
Ø 2.4 mm	712.7129.5	712.7207.5
Ø 3.2 mm	712.7130.5	712.7208.5

Gas nozzle, ceramic (10 pcs.)		Equipment option 1	Equipment option 2
No. 5	Ø 8.0 mm	712.7131.10	712.7133.10
No. 6	Ø 9.5 mm	712.7132.10	712.7134.10
No. 7	Ø 11.0 mm	-	712.7135.10

Technical data according to EN 60 974-7

ACCESSORIES AND SPECIAL PARTS **TIG**

FURTHER WEAR PARTS FOR ABITIG® 17/18/26

Standard with metal sheath

Short

Short with gas lens



Insulating ring	-	Insulating ring (10 pcs.) 701.1219/18CG20	Insulating ring (10 pcs.) 701.1286
------------------------	---	---	--



Collet (10 pcs.)		Short	Short with gas lens
Ø 1.0 mm	-	701.1220	701.1220
Ø 1.6 mm	-	701.1221	701.1221
Ø 2.0 mm	-	701.1222	701.1222
Ø 2.4 mm	-	701.1223	701.1223
Ø 3.2 mm	-	701.1224	701.1224

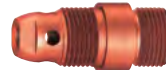

Collet body (10 pcs.)	Standard	Short	Short with gas lens
Ø 0.5 mm	701.0190/10N30	-	-
Ø 1.0 mm	701.0190/10N30	701.1218	701.1287
Ø 1.6 mm	701.0191/10N31	701.1218	701.1288
Ø 2.0 mm	701.0196/10N32	701.1218	-
Ø 2.4 mm	701.0196/10N32	701.1218	701.1289
Ø 3.2 mm	701.0197/10N28	701.1218	701.1290
Ø 4.0 mm	701.0198/406488	-	-



48 mm

30 mm

25.5 mm

Ceramic gas nozzle (10 pcs.)		With metal sheath	Short	Short with gas lens
No. 4	Ø 6.5 mm	-	701.0281/13N08	701.0317/53N58
No. 5	Ø 8.0 mm	701.0124/10N55	701.0282/13N09	701.0318/53N59
No. 6	Ø 9.5 mm	701.0126/10N54	701.0283/13N10	701.0319/53N60
No. 7	Ø 11.0 mm	701.0118/10N53	701.0284/13N11	701.0320/53N61
No. 8	Ø 12.5 mm	701.0120/10N52	701.0285/13N12	-
No. 10	Ø 16.0 mm	701.0122/10N51	701.0286/13N13	-
No. 12	Ø 19.5 mm	-	-	-



L

42 mm

Ceramic gas nozzle (10 pcs.)			L	Short	Reinforced (8.4x19 mm)
No. 4	Ø 6.5 mm	-	48 mm	701.0281/796F71	-
No. 5	Ø 8.0 mm	-	48 mm	701.0282/796F72	-
No. 6	Ø 9.5 mm	-	48 mm	701.0283/796F73	-
No. 7	Ø 11.0 mm	-	-	-	701.0323.10/54N15
No. 8	Ø 12.5 mm	-	-	-	701.0324.10/54N14
No. 4	Ø 6.5 mm	-	63 mm	701.0293/796F75	-
No. 5	Ø 8.0 mm	-	63 mm	701.0294/796F76	-
No. 4	Ø 6.5 mm	-	89 mm	701.0296/796F79	-

ACCESSORIES AND SPECIAL PARTS **TIG**

NARROW GAP GAS NOZZLES FOR ABITIG® 150/260 W

Thanks to the special sword shape of this gas nozzle, even narrow, confined gaps can be reached easily, and good shielding gas coverage is guaranteed. Areas of application: Welding tasks that are difficult to access, e. g. narrow gap welding, root welding, etc.

Narrow gap gas nozzle ABITIG® BG1 (10 pcs.)	Part-No.
8.4x19.0 mm, length 60 mm	777.2170.10



Extended gas nozzle ABITIG® 150/260	Part-No.
Length 60 mm, ND 6.5 mm	777.2175
Length 60 mm, ND 8.0 mm	777.2176

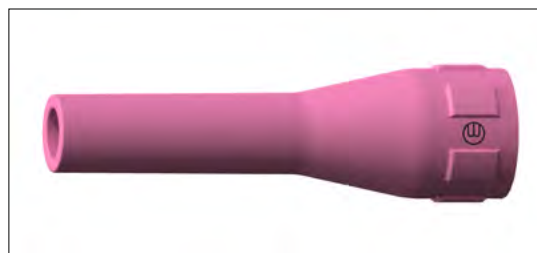

GAS NOZZLE ABITIG® 500 W SHORT

By using the shorter ceramic gas nozzle, the free electrode length is reduced by approx. 15 mm, which results in better cooling of the tungsten electrode. This enables a significantly longer welding time without time-consuming regrinding of the electrode. This offers interesting possibilities for increasing productivity, particularly when using the ABITIG® 500 W MT in automated applications.

Gas nozzle ABITIG® 500 W short (10 pcs.)	Part-No.
Gas nozzle ceramic, ABITIG® 500 W short, ND 9.5	778.1192.10
Gas nozzle ceramic, ABITIG® 500 W short, ND 12.5	778.1193.10
Gas nozzle ceramic, ABITIG® 500 W short, ND 16.0	778.1194.10
Gas nozzle ceramic, ABITIG® 500 W short, ND 19.5	778.1195.10

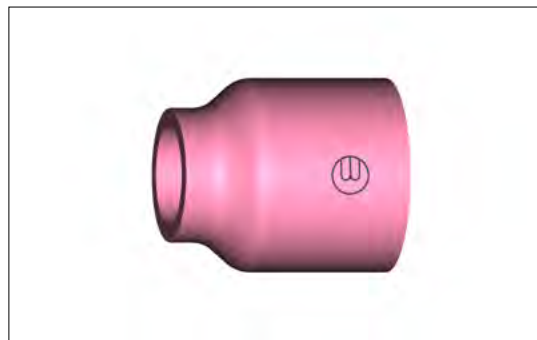

ACCESSORIES AND SPECIAL PARTS **TIG**

METAL GAS NOZZLE FOR ABITIG® 500 W MT

The metal gas nozzle was specially designed for automated welding applications and protects against contact with the workpiece. It is screwed onto the specially designed ceramic gas nozzle for the ABITIG® 500 W MT torch body.

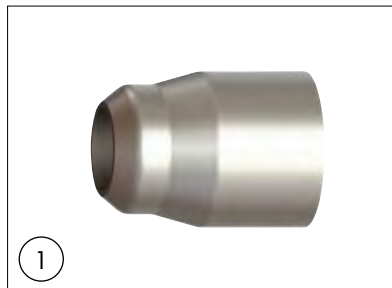

Pos.	Gas nozzle metal for ABITIG® 500 W MT	Part-No.
1	Gas nozzle metal, ND 16 (1 pc.)*	778.1186
1	Gas nozzle metal, ND 19 (1 pc.)*	778.1187
2	Ceramic inner part for gas nozzle (10 pcs.)	778.1185

* The ceramic inner part 778.1185 (position 2) is not included and must be ordered separately.

TORCH MOUNTS ABITIG® MT 260 W / 300 W / 400 W / 500 W

Torch mount	
Description	Part-No.
MT-25 (Ø 25 mm) for ABITIG® MT 150 / 200 / 260 W / 400 W	780.0222
MT-30 (Ø 30 mm) for ABITIG® MT 300 W	780.0145
MT-35 (Ø 35 mm) for ABITIG® MT 500 W	780.0292





ACCESSORIES

CONTENTS ACCESSORIES

		FROM PAGE
ELECTRODE HOLDERS	DE 2200 ▪ DE 2300 ▪ DE 2400 ▪ DE 2500	162
GOUGING TORCHES	K12 ▪ K16 ▪ K20	164
GOUGING TORCHES	G 3000 ▪ G 4000	165
GOUGING ELECTRODES	ABIARC	166
WELDING HELMET	ADF735S	167
ANTI-SPATTER	SUPER PISTOLENSPRAY ▪ SUPER PISTOLENSPRAY NF	168
	SUPER COATING CAP ▪ DÜSOFIX	169
	ABIBLUE NF	170
	CERAMIC SPRAY	172
COOLANT LIQUIDS	CONDUCTIVITY TESTER PRIMO 5	173
	BTC ▪ BTC-NF	174
WELDING ACCESSORIES	UTILITIES ▪ TOOLS ▪ GROUND CLAMPS	176
	ADAPTER PIECES ▪ DOUBLE NIPPLE ▪ QUICK COUPLINGS	178
WELDING CABLE CONNECTOR SYSTEM	ABIPLUG	180
CLEANING MACHINE	ABICLEANER	182
COOLANT RECIRCULATORS	CR 1000 ▪ CR 1250	184

ELECTRODE HOLDERS

DE 2200 ■ DE 2300 ■ DE 2400 ■ DE 2500



The durable classics – the original

Electrode holders are used for manual electrode welding. These classics from ABICOR BINZEL with their compression spring holder – often referred to as KURT HAUFE “Black & White” or “German Style” – are a symbol of quality and reliability MADE IN GERMANY. Overseas in particular, they have been a legendary market leader for decades. They are one of the most copied tools for arc welding, but their replicas have never achieved the same reliability and quality.

Due to their extremely robust design, these compression spring electrode holders are the ideal tool for outdoor professionals and are used in pipeline and bridge construction as well as in shipyards.

Special features:

- High-tensile, heat insulated handle
- Mechanical and thermal heavy-duty insulating material
- Safe electrode voltage in four chip flutes
- Big electrode and welding cable connection area



Technical data

Type	Rating		Elektrodes-Ø	Welding cable	Connection bolt**
	at 60% duty cycle	at 35% duty cycle			
DE 2200	200 A	250 A	2.0-4.0 mm	25/35 mm**	M8
DE 2300	300 A	400 A	2.0-6.3 mm	35/70 mm**	M8
DE 2400	400 A	500 A	4.0-8.0 mm	50/95 mm**	M10
DE 2500	500 A	600 A	4.0-10.0 mm	70/120 mm**	M10

**for cable shoe

Electrode holder cpl.



Type	Part-No.
Electrode holder DE 2200	512.D060
Electrode holder DE 2300	512.D070
Electrode holder DE 2400	512.D080
Electrode holder DE 2500	512.D090

Wear parts

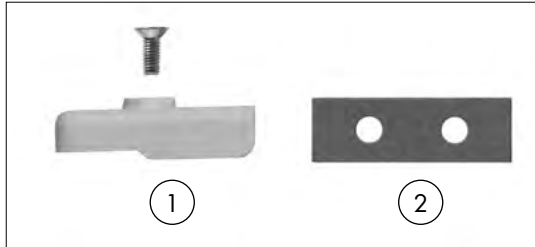

Position	Description	Part-No.			
		DE 2200	DE 2300	DE 2400	DE 2500
1	Insulating flange (2 pcs.)	512.D021	512.D031	512.D041	512.D091
2	Insulating plate	-	512.D032	512.D032	512.D032

GOUGING TORCH

K12 ■ K16 ■ K20



Reliable and safe

Arc gouging torches are the ideal tool for convenient and safe gouging, seam preparation and finishing, gouging of blowholes and cracks, chamfering, cutting and piercing in all metals. A power range of 600 to 1,500 amps is covered in 3 load levels.

The simple and robust design characterizes these gouging torches, originally known under the KURT HAUFE brand, as well as the possibility of precise air flow regulation by means of a cone valve. A highly flexible special cable and the optional rotary connection round off the design and ensure an optimum price-performance ratio overall.

Special features:

- Oval, rugged, heat insulated handle
- Regulation of compressed air via rotary valve
- High air consumption
- High flex cable
- Turnable nozzle suitable for round and flat electrodes



Technical data

Type	Rating	Duty cycle	Round electrode-Ø	Flat electrode		Compr. air max.	Compr. air connection
				width (mm)	thickness (mm)		
K12	600 A	60%	4-12 mm	15/20	4-5	10 bar	3/8"-18 NPT
K16	1000 A	60%	8-16 mm	15/20/25	4-5	10 bar	3/8"-18 NPT
K20	1500 A	60%	8-19 mm	15/20/25	4-5	10 bar	3/8"-18 NPT

Gouging torch cpl.

Type	Description	Part-No.	
		2.1 m	3.0 m
Gouging torch K12	cpl. with cable assembly	516.D125	516.D002
Gouging torch K16	cpl. with cable assembly	516.D126	516.D003
Gouging torch K20	cpl. with cable assembly	-	516.D167.1



GOUGING TORCH **TEAM BINZEL®**

G 3000 ■ G 4000

Rugged and easy to handle ...

The TEAM BINZEL® gouging torches G 3000 and G 4000 are safe and easy to handle. They are designed to be used for gouging, weld seam preparing, gouging out of blowholes and cracks, chamfering, cutting, surface resurfacing and keyhole cutting for all common materials.

Special features:

- Rugged and heat resistant handle
- Turnable nozzle suitable for round and flat electrodes
- High air consumption
- High flex cable
- Swivel joint



Technical data

Type	Rating	Duty cycle	Nom. air pressure	Nom. volume flow	Connection air supply
G 3000	max. 600 A	60%	7 bar	approx. 0.60 m ³ /min.	3/8"-18 NPT
G 4000	max. 1000 A	35%	7 bar	approx. 0.70 m ³ /min.	3/8"-18 NPT

Gouging torch **TEAM BINZEL®** **G 3000**

Type	Part-No.
Gouging torch TEAM BINZEL® G 3000 (torch only)	516.0001
Gouging torch TEAM BINZEL® G 3000 cpl. with cable assembly (length = 2.1 m)	516.0002
Gouging torch TEAM BINZEL® G 3000 cpl. with cable assembly (length = 3.0 m)	516.0003
Cable assembly, length = 2.1 m	516.0004
Cable assembly, length = 3.0 m	516.0005

Gouging torch **TEAM BINZEL®** **G 4000**

Type	Part-No.
Gouging torch TEAM BINZEL® G 4000 (torch only)	516.0001
Gouging torch TEAM BINZEL® G 4000 cpl. with cable assembly (length = 2.1 m)	516.0002
Gouging torch TEAM BINZEL® G 4000 cpl. with cable assembly (length = 3.0 m)	516.0003
Cable assembly, length = 2.1 m	516.0004
Cable assembly, length = 3.0 m	516.0005



GOUGING ELECTRODES **TEAM BINZEL®**

ABIARC



Pure efficiency

TEAM BINZEL® gouging electrodes are made of artificial graphite and have a pure copper coating. The gouging electrodes are available in the variety of shapes and diameters to meet the needs of various applications.

Special features:

- Pure copper coated – good electric conductivity
- High density (made of artificial graphite) – high metal removal rate
- Less consumption of electrodes – cost reduction
- Constant quality – for a safe process
- High metal removal rate – effective process
- Extremely low burn back rate



Order overview ABIARC gouging electrodes

ABIARC gouging electrodes (DC) pointed				
Type		Ampere	Pcs.	Part-No.
4 x 305 mm	(5/32" x 12")	250	50	515.0015
5 x 305 mm	(3/16" x 12")	300	50	515.0016
6.5 x 305 mm	(1/4" x 12")	400	50	515.0017
8 x 305 mm	(5/16" x 12")	500	50	515.0018
9.5 x 305 mm	(3/8" x 12")	600	50	515.0019
13 x 355 mm	(1/2" x 14")	900	50	515.0020

ABIARC gouging electrodes (AC) pointed				
Type		Ampere	Pcs.	Part-No.
6.5 x 305 mm	(1/4" x 12")	350	50	515.0023
9.5 x 305 mm	(3/8" x 12")	450	50	515.0024

ABIARC gouging electrodes (DC) flat				
Type		Ampere	Pcs.	Part-No.
10 x 5 x 305 mm		400	50	515.0025
15 x 5 x 305 mm		550	50	515.0026

ABIARC gouging electrodes (DC) jointed				
Type		Ampere	Pcs.	Part-No.
9.5 x 430 mm	(3/8" x 17")	600	50	515.0027
13 x 430 mm	(1/2" x 17")	1400	50	515.0028
16 x 430 mm	(5/8" x 17")	1800	50	515.0029
19 x 430 mm	(3/4" x 17")	2000	50	515.0030

WELDING HELMET

ADF735S

The ADF735S welding helmet combines quality with advanced features.



Technical data

Optical class: 1/1/1/2
 Display size: 96 x 53 mm
 Cassette: True color
 Switch time: 1/25.000 sec
 Lens shade: 9-13

Standards: CE, UKCA
 Sensors: 4
 Power supply: Solar cell & Battery
 (with battery indicator)

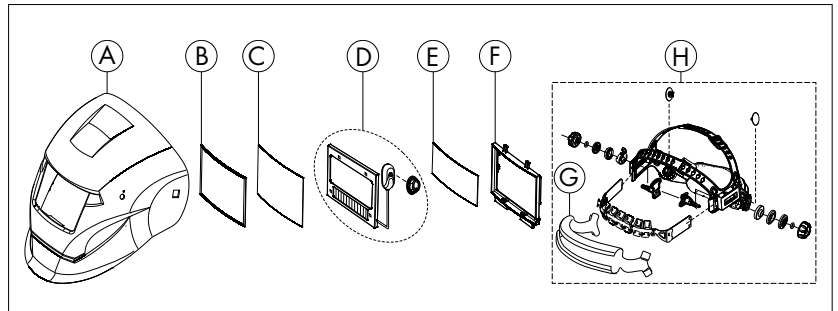

Welding helmet ADF735S

Pos.	Description	Part-No.
15	Welding helmet ADF735S, automatic darkening	519.0018.1

Spare parts for welding helmet ADF735S

Pos.	Description	Included articles								Part-No.
		A	B	C	D	E	F	G	H	
B/C/E	Front cover lens set	-	2	10	-	1	-	-	-	519.0019.1
B/C/E	Front cover lens set with mounted rubber holder	-	10	10	-	1	-	-	-	519.0024.1
A/F	Shell with lens holder set	1	-	-	-	-	1	-	-	519.0020.1
H	Headgear complete	-	-	-	-	-	-	-	1	519.0021.1
D	Automatic welding protection filter	-	-	-	1	-	-	-	-	519.0022.1
G	Sweatband	-	-	-	-	-	-	3	-	519.0023.3

ANTI-SPATTER

SUPER PISTOLENSPRAY NF ■ SUPER PISTOLENSPRAY

Non-flammable anti-spatter-spray for torches and workstations

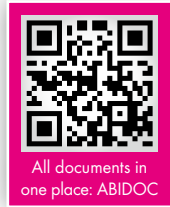

The newly developed Super Pistolenspray NF is a non-flammable anti-spatter agent for torch and workpiece.

It can be used anywhere, especially where the use of flammable sprays is not possible or even prohibited, such as: in closed rooms, in container and shipbuilding.

Based on an aqueous emulsion of vegetable oils, the new Super Pistolenspray NF contains no hazardous substances and is therefore not subject to any separate safety regulations, neither during transport or storage nor during of use.

Thanks to its neutral behavior towards the welding process and thanks to its corrosion inhibitors, it can also be applied to the gas nozzle of the torch and the workpiece for protection against spatters and corrosion.

- Non flammable according ABICOR BINZEL NF standard
- Silicone-free, wax-free and water-soluble
- Neutral behavior towards the welding process
- Corrosion inhibitors protect equipment and surfaces
- Aspraying behavior optimized for workpiece and gas nozzle
- More usable release agent with the same can size

Super Pistolenspray NF	
Description	Part-No.
Super Pistolenspray NF*, 400 ml ■ 12 pcs. ■ languages: DE/EN/FR/IT/ES/NL/PT/PL/CS/RU/UK/ZH**	192.0315.1

*When used for welding aluminium or special alloys, a welding test should always be carried out beforehand.



The classical Anti-Spatter-Spray

ABICOR BINZEL Super Pistolenspray is a special silicon-free formula developed on the basis of environmentally-friendly, solvent-free natural special oils that are not harmful to health, and additives that do not have to be specifically labelled.

The Anti-Spatter-Spray has been successfully used in all sectors of the metalworking industry and is in demand daily in very different areas of application.

- Silicon-free
- Environmentally friendly raw materials as a basis
- Solvent-free



Super Pistolenspray	
Description	Part-No.
Super Pistolenspray, 400 ml ■ 12 pcs. ■ languages: DE/EN/FR/NL/SV/DA/FI/IT**	192.0071
Super Pistolenspray, 400 ml ■ 12 pcs. ■ languages: CS/SK/PL/HU/HR/SL/SR/EN**	192.0107
Super Pistolenspray, 400 ml ■ 12 pcs. ■ languages: RU/UK/LT/LV/ET/BG/RO**	192.0213.1
Super Pistolenspray, 400 ml ■ 12 pcs. ■ languages: EN/ZH/ES/EL/PT/NO/TR**	192.0214.1

** The respective article may only be sold in countries whose official languages are listed here.

ANTI-SPATTER SUPER COATING CAP ■ DÜSOFIX

Super Coating Cap



The contact tip and the front of the gas nozzle are ideally protected against welding spatter with the Super Coating Cap especially for the ABICOR BINZEL Super Pistolenspray. Simply attach and dose optimally.

- Economical to use, good for your wallet
- Targeted spraying protects the welder and the environment
- Time-saving thanks to easy handling
- Optimal wetting of contact tip and gas nozzle
- Multiple uses

Super Coating Cap	
Description	Part-No.
Super Coating Cap ■ 10 pcs.	192.0409.1

Nozzle protection paste

Düsofix is a spatter protection paste for gas nozzles. Biodegradable, special labeling not required, silicon-free. The metal can enables the hot gas nozzle to be dipped safely into the Düsofix – even directly after the welding process. The spatter adhesion is reduced by the protective film.

- Silicon-free
- Special labelling not required
- Can also be used on hot gas nozzles



Düsofix	
Description	Part-No.
Düsofix, 300 g ■ 12 pcs. ■ languages: DE/EN/FR/SV	192.0058
Düsofix, 300 g ■ 12 pcs. ■ languages: CS/SK/PL/RO/BG	192.D032
Düsofix, 300 g ■ 12 pcs. ■ languages: RU/HU/LT/LV/ET	192.D033
Düsofix, 300 g ■ 12 pcs. ■ languages: ES/IT/PT/EL/TR	192.0224.1

ANTI-SPATTER ABIBLUE NF

Welding spatter gets the blues!



ABIBLUE NF does away with welding spatter adhesions on the workpiece in a particularly effective way and thus saves time and money. It contains a blue colour indicator that shows the welder immediately whether the workpiece is covered with a separating agent – naturally without influencing the welding process.

Usable for all relevant welding methods, as well as for laser and plasma cutting. This simplifies handling in larger operations with different welding and cutting processes.

Safety for subsequent coating/painting/galvanising was ensured in cooperation with an independent testing institution.

This spatter protection variant is particularly environmentally friendly through the use of sustainable raw materials.

The advantages of ABIBLUE NF

- Non-flammable – satisfies the ABICOR BINZEL NF standard
- Special labeling not required in accordance with GHS/CLP
- Easily biodegradable
- Can be washed off with water
- Silicon-free
- Colour indicator – optimal detection of workpiece wetting
- Suitable for welding and laser cutting applications
- Capability of being welded over confirmed by an independent testing institution
- No adverse effects with subsequent coating/painting/galvanising if standard pre-treatment methods are complied with



Detecting what will not ignite even faster: the stamp for NF products from ABICOR BINZEL

ABICOR BINZEL NF-STANDARD

Products from ABICOR BINZEL that have the abbreviation “NF” (non-flammable) in their name have passed practical tests developed by ABICOR BINZEL especially for welding technology.

The standard defined by ABICOR BINZEL for NF products goes further than the provisions of the GHS and of the CLP Regulation on the classification of the flammability of an NF product and covers a broad range of standard combinations of active shielding

gases, extremely different workpieces and different welding processes.

Only products that have passed all the tests without igniting may show the ABICOR BINZEL NF designation. In addition to the “NF” in the name, products are also marked with a stamp.

The ABICOR BINZEL NF standard provides more safety for welders and companies.

**ABIBLUE NF
anti-spatter-
emulsion**



ABIBLUE NF anti-spatter-emulsion		
Position	Description	Part-No.
1	ABIBLUE NF anti-spatter-emulsion, 5 litre canister; languages: DE/EN/FR/IT/RU/UK	192.0238.1
2	ABIBLUE NF anti-spatter-emulsion, 10 litre canister; languages: DE/EN/FR/IT/RU/UK	192.0239.1
3	ABIBLUE NF anti-spatter-emulsion, 20 litre canister; languages: DE/EN/FR/IT/RU/UK	192.0240.1
not fig.	ABIBLUE NF anti-spatter-emulsion, 200 litre barrel*; languages: DE/EN/FR/IT/RU/UK	192.0241.1
4	Outlet tap RD 45, for 5 and 10 litre canister ■ 2 pcs.	192.0399.2
5	Outlet tap RD 61, for 20 litre canister ■ 2 pcs.	192.0400.2
not fig.	Outlet tap for 200 litre barrels ■ 1 pc.	192.0109

*Can be used for at least 6 months without remixing if stored and transported frost-free.
In order to guarantee maximum durability, the barrels are not in stock, but the delivery time is only approx. 2 weeks.

**ABIBLUE NF
spray bottles**

The sprays have spray heads specially designed for ABIBLUE NF and thus ensure an optimum spraying pattern. The spray head can be set to the required spraying pattern before use, and the workpiece can be evenly sprayed and wetted. Suitable for use with ABIBLUE NF anti-spatter-emulsion.

The metal spray bottle is our robust solution for keeping ABIBLUE NF close to the process. Thanks to its solid metal body, it is insusceptible to heat and welding spatter.

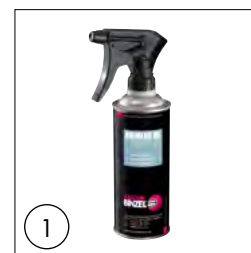

A plastic spray bottle is available as an alternative to the metal spray bottle. This does not require pressure compensation and is thus leak proof.



ABIBLUE NF spray bottles		
Position	Description	Part-No.
1	Metal spray bottle complete, without contents, 520 ml ■ 12 pcs.	192.0163
2	Insert hand spray pump for metal spray bottle ■ 1 pc.	192.0164
3	Plastic spray bottle complete, without contents, 500 ml ■ 15 pcs.	192.0254.15

ANTI-SPATTER CERAMIC SPRAY

Premium anti-spatter-spray for torches



ABICOR BINZEL Ceramic Spray is resistant to high temperatures and provides long-term protection from welding spatter adhesions on gas nozzle and contact tips, and on all welding process fixtures. ABICOR BINZEL Ceramic Spray increases system availability and lowers ongoing maintenance costs. It is also perfectly suitable for automated applications with long welding processes.

After spraying, a white ceramic protective film is formed that is resistant to high temperatures. Thanks to the extremely short drying time of approx. 5 seconds, the welding process can be started immediately.

- Silicone-free
- Very high ceramic content – wide coverage
- Lowers ongoing maintenance costs
- Increases system availability
- Excellent coating adhesion
- High abrasion resistance
- Very short drying time (approx. 5 seconds)
- For all MIG/MAG torches
- For all processes

ABICOR BINZEL Ceramic Spray



ABICOR BINZEL Ceramic Spray	
Description	Part-No.
Ceramic Spray, 400 ml ■ 12 pcs. ■ languages: DE/EN/FR/NL/ES/PT/IT/SV*	192.0228.1
Ceramic Spray, 400 ml ■ 12 pcs. ■ languages: RU/CS/SK/PL/LT/LV/ET/EN*	192.0229.1
Ceramic Spray, 400 ml ■ 12 pcs. ■ languages: EN/FI/SV/NO/DA/TR/ZH/EL*	192.0242.1

Ceramic Coating Cap



The Ceramic Coating Cap was developed specially for ABICOR BINZEL Ceramic Spray. The contact tip as well as the tip of the gas nozzle and its interior can be optimally protected in a few seconds from adhering welding spatter with the Ceramic Coating Cap.

- Cost savings through lower consumption
- Protects the welder and the environment
- Time savings through better handling
- Optimum wetting of the gas nozzle
- Can be reused several times

Ceramic Coating Cap	
Description	Part-No.
Ceramic Coating Cap ■ 10 pcs.	192.0256.1

* The respective article may only be sold in countries whose official languages are listed here.

COOLANT LIQUIDS CONDUCTIVITY TESTER

Primo 5

Low conductivity of the coolant in liquid cooled welding and cutting equipment has been shown to increase the lifetime of the hose package, torch and cooling unit and should therefore be checked at regular intervals.

The new conductivity tester Primo 5 is ideally suited for checking the conductivity and, thanks to its compact design, allows a faster and less complicated measurement than its predecessor.

Its long, rugged probe requires low maintenance while still ensuring accurate measurement. The measured value is easy to read via the large display. Temperature compensation is automatic via integrated temperature sensor and the calibration is done automatically via a special calibration liquid.

Conductivity tester Primo 5	
Description	Part-No.
Conductivity tester Primo 5	514.0062.1
Calibration liquid bottle 230 ml	514.0311.1



Recommended maximum conductivity:

MIG/MAG	350 $\mu\text{S}/\text{cm}$
TIG	250 $\mu\text{S}/\text{cm}$
Plasma	30 $\mu\text{S}/\text{cm}^*$

*applies to products from ABICOR BINZEL, for competitor products, the manufacturer's specifications are to be observed!

Technical data:

Range:	0 bis 1999 $\mu\text{S}/\text{cm}$
Resolution:	1 $\mu\text{S}/\text{cm}$
Accuracy:	$\pm 2\%$ of the display
Calibration:	Automatic with calibration liquid (1413 $\mu\text{S}/\text{cm}$)
Temperature compensation:	Automatic between 0 and 50°C
Battery type/lifetime:	2 x 1.5 V, approx. 200 hours of continuous use
Automatic shutdown:	After 5 min.
Dimensions:	180 x 50 x 25 mm
Weight:	50 g

COOLANT LIQUIDS

BTC ■ BTC-NF

Coolants for all welding and cutting systems



Liquid cooled torches require special coolants. These should have very good cooling properties, low electrical conductivity and in addition good storage properties. ABICOR BINZEL BTC coolants satisfy these requirements reliably, ensure optimal cooling of liquid cooled welding and cutting torches and thus provide perfect protection for the complete cooling system.

- Optimal cooling of torches
- Long life in the cooling system
- Prevents a rapid increase in the electrical conductivity – electrical corrosion on metal parts is considerably reduced
- The complete cooling system is protected from blockages and consequential damage
- Suitable for all welding and cutting systems

BTC-15



- Very low conductivity value of $< 4 \mu\text{S}/\text{cm}$.
- Frost-proof up to -12°C
- Silicone-free
- pH value: 6



Coolant liquid BTC-15		
Position	Description	Part-No.
1	BTC-15, 5 litre canister ■ languages: DE/EN/FR/ES/CS/SK/PL/RU*	192.0110
2	BTC-15, 20 litre canister ■ languages: DE/EN/FR/ES/CS/SK/PL/RU*	192.0111
3	Outlet tap RD 45, for 5 und 10 litre canister ■ 2 pcs.	192.0399.2
4	Outlet tap RD 61, for 20 litre canister ■ 2 pcs.	192.0400.2
not fig.	BTC-15, 200 litre barrel ■ languages: DE/EN/FR/CS/PL/RU*	192.0112
5	Outlet tap for 200 litre barrels ■ 1 pc.	192.0109

* The respective article may only be sold in countries whose official languages are listed here.

BTC-20 NF



- Very low conductivity value of <math>< 4 \mu\text{S}/\text{cm}</math>.
- Non-flammable - conforms to the ABICOR BINZEL NF standard
- Uncomplicated storage - non-flammable product
- Frost-proof up to -17°C
- Silicone-free
- pH value: 6



Coolant liquid BTC-20 NF

Position	Description	Part-No.
6	BTC-20 NF, 5 litre canister ■ Languages: DE/EN/FR/ES/CS/SK/PL/RU*	192.0265.1
6	BTC-20 NF, 5 litre canister ■ Languages: DE/FR/NL/TR/NO/DA/PT/SV*	192.0266.1
7	BTC-20 NF, 20 litre canister ■ Languages: DE/EN/FR/ES/CS/SK/PL/RU*	192.0267.1
7	BTC-20 NF, 20 litre canister ■ Languages: DE/FR/NL/TR/NO/DA/PT/SV*	192.0268.1
8	Outlet tap RD 45, for 5 und 10 litre canister ■ 2 pcs.	192.0399.2
9	Outlet tap RD 61, for 20 litre canister ■ 2 pcs.	192.0400.2
not fig.	BTC-20 NF, 200 litre barrel ■ Languages: DE/EN/FR/CS/PL/RU*	192.0269.1
10	Outlet tap for 200 litre barrels ■ 1 pc.	192.0109

BTC-50 NF



- Very low conductivity value of <math>< 4 \mu\text{S}/\text{cm}</math>.
- Non-flammable - conforms to the ABICOR BINZEL NF standard
- Uncomplicated storage - non-flammable product
- Frost-proof up to -45°C
- Silicone-free
- pH value: 6



Coolant liquid BTC-50 NF

Position	Description	Part-No.
11	BTC-50 NF, 5 litre canister ■ languages: DE/EN/FR/ES/CS/SK/PL/RU*	192.0175.1
11	BTC-50 NF, 5 litre canister ■ languages: DE/FR/NL/TR/NO/DA/PT/SV*	192.0260.1
12	BTC-50 NF, 20 litre canister ■ languages: DE/EN/FR/ES/CS/SK/PL/RU*	192.0176.1
12	BTC-50 NF, 20 litre canister ■ languages: DE/FR/NL/TR/NO/DA/PT/SV*	192.0261.1
13	Outlet tap RD 45, for 5 und 10 litre canister ■ 2 pcs.	192.0399.2
14	Outlet tap RD 61, for 20 litre canister ■ 2 pcs.	192.0400.2
not fig.	BTC-50 NF 200 litre barrel ■ languages: DE/EN/FR/CS/PL/RU*	192.0177.1
15	Outlet tap for 200 litre barrels ■ 1 pc.	192.0109

* The respective article may only be sold in countries whose official languages are listed here.

WELDING ACCESSORIES

UTILITIES ■ TOOLS ■ GROUND CLAMPS

Special pliers and wire cleaning sets

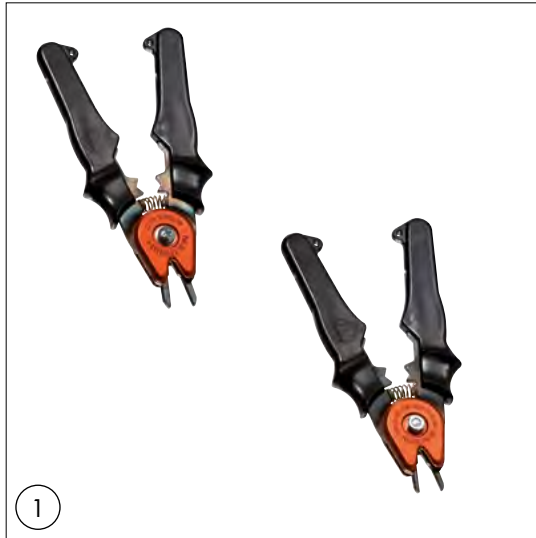

- 1 **Special pliers (FIX)**
 No. 1 ■ for gas nozzles
 NW 12–15 mm Part-No.: 193.0013
 No. 2 ■ for gas nozzles
 NW 15–18 mm Part-No.: 193.0014

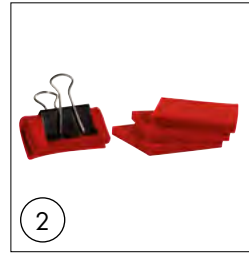

- 2 **Wire cleaning set**
 red for steel (set)
 red for steel (25 pcs.)

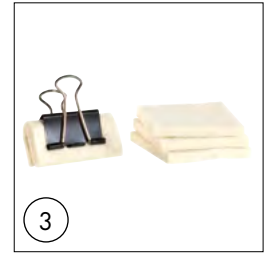

- 3 **Wire cleaning set**
 white for Al (set)
 white for Al (25 pcs.)



- 4 **Clamp**
 (12 pcs.)
 Part-No.: 193.0007

Handy-supports, sharpener, hose cutters and gas flow meters



- 5 **TIG handy-support (FIX)**
 without magnet base Part-No.: 193.0019



- 6 **MIG-Handy-Support (FIX)**
 without magnet base Part-No.: 193.0018

Magnet base (not fig.) Part-No.: 193.0023



- 7 **Sharpener**
 for liners Part-No.: 191.0064



- 8 **Hose cutter** Part-No.: 191.0062.1

- 9 **Gas flow meter** Part-No.: 191.0003

Accessories case, Wire brushes



- 10 **Accessories case**
 small Part-No.: 192.0066
 big Part-No.: 192.0069



- 11 **Wire brushes** **Part-No.**
 Stainl. steel, 290 mm, Ø 0.35 mm 514.0043.1
 Brass steel wire universal brush,
 260 mm, Ø 0.30 mm 514.0049.1

Special wrenches

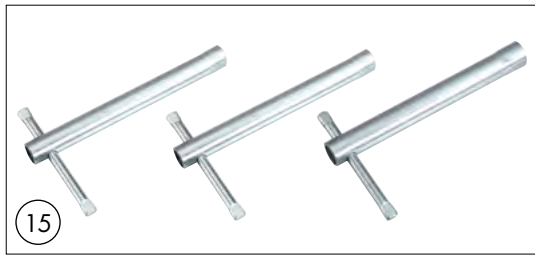
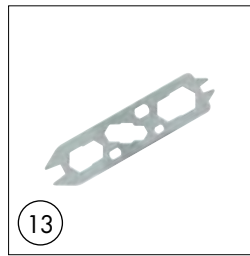
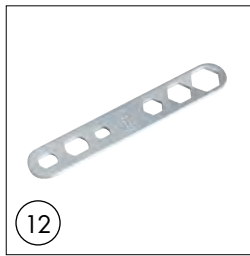

12 Multiple wrench

Standard

Part-No.: 191.0001

13 Multiple wrench

for ABIMIG® ABIMIG®

Part-No.: 191.D045

14 Multiple wrench

Type MB EVO PRO

Part-No.: 191.0193.10

15 Socket wrench (L=120 mm)

SW 6

Part-No.: 191.0103

SW 8

Part-No.: 191.0102

SW 10

Part-No.: 191.0104

Ground clamps for screwing, clamping or with magnet



Ground clamps

Position	Description	Rating	Part-No.
16	ABIGATOR 25	Duty cycle 60% 200 A / Duty cycle 100% 157 A	513.0013.1
17	ABIGATOR 35 XL	Duty cycle 60% 250 A / Duty cycle 100% 196 A	513.0014.1
18	ABIGATOR 50	Duty cycle 60% 300 A / Duty cycle 100% 248 A	513.0015.1
19	ABIGATOR 70	Duty cycle 60% 400 A / Duty cycle 100% 309 A	513.0024.1
20	ABIGATOR 95	Duty cycle 60% 400 A / Duty cycle 100% 309 A	513.0027.1
21	ABIGATOR 120	Duty cycle 60% 500 A / Duty cycle 100% 374 A	513.0026.1
22	ABIMAGNET	Duty cycle 60% 400 A / Duty cycle 100% 309 A	513.0029.1

Chipping hammers



23 Chipping hammers

Type "Splitter steel", tube handle steel, 420 g

Part-No.: 514.0028.1

Type "D-Style", wooden handle, 470 g

Part-No.: 514.0037.1

Type "S-Style", wooden handle, 150 g

Part-No.: 514.0038.1

WELDING ACCESSORIES

ADAPTER PIECES ■ DOUBLE NIPPLE

QUICK COUPLINGS

Quick couplings

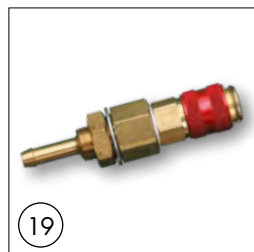
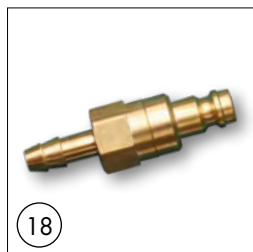
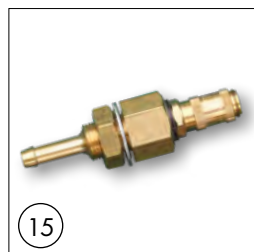
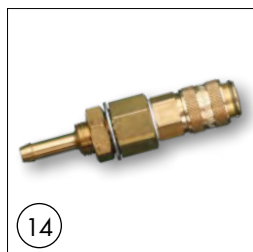
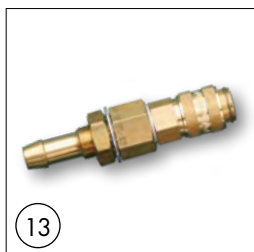
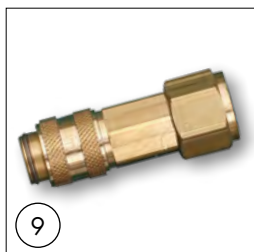
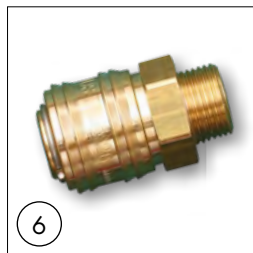
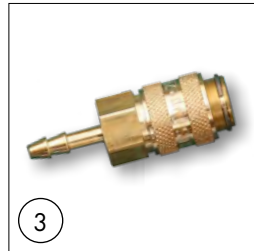
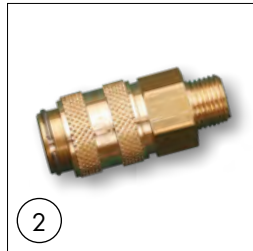
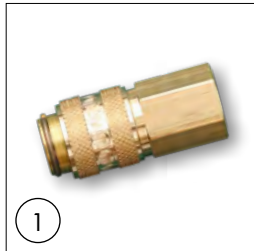

Quick couplings		
Position	Description	Part-No.
1	Quick coupling DN 5 G1/8" IG	177.0002
2	Quick coupling DN 5 G1/8" AG	177.0003
3	Quick coupling DN 5 nozzle Ø = 4 mm	177.0007
4	Quick coupling DN 2.7 nozzle Ø = 4 mm	177.0009
5	Quick coupling DN 5 nozzle Ø = 6 mm ■ self-locking	177.0016.10
6	Quick coupling G3/8" AG	177.0012
7	Quick coupling DN 5 G1/8" AG ■ red	177.0013
8	Quick coupling DN 5 G1/8" AG ■ blue	177.0014
9	Quick coupling DN 5 G1/4" IG	501.0158
10	Quick coupling DN 5 5/8" - 18G UNF-LH AG	501.0188
11	Quick coupling DN 5 G3/8" IG	501.0189
12	Quick coupling DN 5 nozzle Ø = 8 mm	501.0190
13	Quick coupling DN 5 nozzle Ø = 10 mm	501.0195
14	Quick coupling DN 5 nozzle Ø = 6.5 mm	501.0204
15	Quick coupling DN 2.7 nozzle Ø = 6.5 mm	501.0230
16	Quick coupling DN 5 nozzle Ø = 6 mm	501.0270
17	Quick coupling DN 5 5/8" - 18G UNF IG	501.1795
18	Plug-in nipple DN 5 ■ self-locking	501.2318
19	Quick coupling DN 5 nozzle Ø = 6.5 mm ■ red	501.2403
20	Quick coupling DN 5 nozzle Ø = 6.5 mm ■ blue	501.2404
21	Quick coupling DN 5 nozzle Ø = 6 mm	560.0017
22	Quick coupling DN 5 CRNG20 ■ Roll-Liner NG	783.5207.1
23	Quick coupling DN 5 1/4" AG	850.0263

Adapter pieces



Adapter pieces	
Bezeichnung	Part-No.
Adapter piece M12x1 - G3/8"	710.0003
Adapter piece M12x1 - G1/4"	710.0004
Adapter piece M12x1 - G1/8"	710.0009

Double nipple

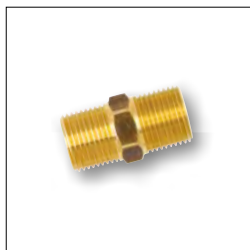

Double nipple	
Bezeichnung	Part-No.
Double nipple G1/8" AG/G1/8" AG SW 12 (MS)	710.0016
Double nipple M12x1 AG/M12x1 AG SW 12 (MS)	710.0017

WELDING CABLE CONNECTOR SYSTEM

ABIPLUG



All documents in one place: ABIDOC

Plug & weld! ABIPLUG – the reliable connection.

The new range of ABIPLUG welding cable connectors from ABICOR BINZEL – designed for safe and effective current transfer in arc welding technology – guarantees maximum operating safety for the equipment and the user. Available as either panel socket / cable plug combination or as panel plug / cable socket combination.

The advantages:

- Safe and quick connection – highest twist resistance due to the revolutionary “square end-block-system” by ABICOR BINZEL
- High flash-over resistance – for maximum machine protection
- Easy mounting, optimal connection and excellent power transmission
- Compatible with all commercially available makes – can be built out of metal or plastic panels
- Corresponds to EN-standard EN 60 974-12 – the new EN-standard

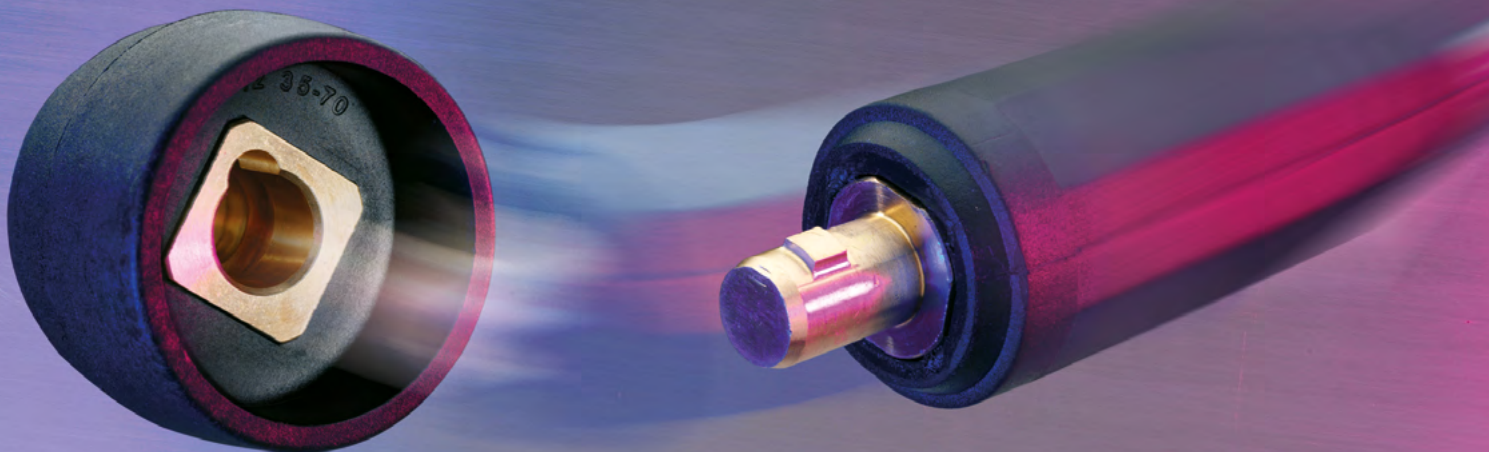

Technical data

Welding cable connector system			
Type	Current (A)	Cable (mm ²)	Mount-Ø (mm)
*10-25	125	bis 10	20.5
*10-25	150	10-16	20.5
*10-25	200	16-25	20.5
*35-50	250	25-35	30.5
*35-50	300	35-50	30.5
*50-70	400	50-70	30.5
*70-95	500	70-95	30.5

* = **ABI-CM / ABI-IF** oder **ABI-CF / ABI-IM**

ABI-CM (Cable Male) = Welding cable plug

ABI-CF (Cable Female) = Welding cable socket

ABI-IM (Insert Male) = Panel mounted plug

ABI-IF (Insert Female) = Panel mounted socket



Panel sockets

- 1 ABI-IF 10-25
- 2 ABI-IF 35-50
- 3 ABI-IF 50-70
- 4 ABI-IF 70-95

- Part-No.: 511.0304
- Part-No.: 511.0314
- Part-No.: 511.0330
- Part-No.: 511.0309

Cable plugs

- 5 ABI-CM 10-25
- 6 ABI-CM 35-50
- 7 ABI-CM 50-70
- 8 ABI-CM 70-95

- Part-No.: 511.0305
- Part-No.: 511.0315
- Part-No.: 511.0331
- Part-No.: 511.0342



Panel plugs

- 9 ABI-IM 10-25
- 10 ABI-IM 35-50
- 11 ABI-IM 50-70
- 12 ABI-IM 70-95

- Part-No.: 511.0306
- Part-No.: 511.0316
- Part-No.: 511.0332
- Part-No.: 511.0320

Cable sockets

- 13 ABI-CF 10-25
- 14 ABI-CF 35-50
- 15 ABI-CF 50-70
- 16 ABI-CF 70-95

- Part-No.: 511.0303
- Part-No.: 511.0313
- Part-No.: 511.0329
- Part-No.: 511.0340



CLEANING MACHINE ABICLEANER

In many industrial production processes, tarnish is undesirable because the appearance matters – this is where the ABICLEANER can prove its skills. Especially when welding stainless steel, so-called tarnish colours are produced, which do not look very nice on railings, facades, switch cabinets etc. and ideally have to be removed again gently. The use of pickling pastes or other abrasives and grinding tools is highly toxic on the one hand and leaves unsightly marks on the sensitive stainless steel surface on the other. Anyone who has ever tried to clean an extractor hood in the kitchen, for example, with a felt sponge and scouring agent, will be familiar with these unsightly scratch marks on the surface.

With the ABICLEANER, even delicate surface structures such as waffle patterns are not changed and retain their original appearance.

In addition to the gentle cleaning of the surface, which is conducted with a hydrofluoric acid-free solution, the ABICLEANER also has the property of restoring corrosion resistance after mechanical, chemical and thermal treatments. Stainless steel forms a layer of chromium oxide for protection, as the chromium in the stainless steel combines with oxygen and hydrogen from the environment, making the metal resistant to corrosion. After cleaning the weld seam surface with the ABICLEANER, the precious metal is also directly protected against corrosion again; this is also referred to as having been “passivated”.



- Gentle on the surface – facilitated by the carbon fibre brush made of over 1.5 million filaments
- Fast & effective – due to the electrochemical effect
- Safe – free of hydrofluoric acid
- Simple – only one fluid for cleaning and polishing (polishing possible with the ABICLEANER 1000 AC/DC)
- Powerful – professional units with 100% duty cycle





ABICLEANER ▪ Accessories

Pos.	Description	Part-No.
1	ABICLEANER 800 AC ¹ cleaning set (230 V)	192.0362.1
1	ABICLEANER 800 AC ¹ cleaning set (120 V)	192.0374.1
2	ABICLEANER 1000 AC/DC ¹ cleaning set (230 V)	192.0364.1
2	ABICLEANER 1000 AC/DC ¹ cleaning set (120 V)	192.0375.1
3	ABICLEANER handle with 10 mm ² cable, 4 m	192.0365.1
4	PTFE sleeve	192.0368.1
5	ABIBRUSH carbon fibre brush	192.0367.5
6	Earth clamp with 10 mm ² cable, 4 m	192.0366.1
7	Combination spanner SW 10	192.0372.10
8	ABICLEAN all-in-one electrolyte, 1 litre, (12 pcs.)	192.0369.1
9	Spray bottle for water, (12 pcs.)	192.0371.1
10	Wide-necked container with blue lid, (12 pcs.)	192.0370.1
11	Adaptor for ABICLEANER handle, 10 mm ²	192.0379.1
12	Protective cap carbon fibre brush	192.0427.25
not fig.	ABICLEAN all-in-one electrolyte, 5 litres	192.0378.1
not fig.	Euro plastic box ²	192.0373.1

¹ The ABICLEANER 800 AC or ABICLEANER 1000 AC/DC cleaning sets each also include the items: 3, 4, 5, 6, 7, 8, 9, 10 and the euro plastic box.

² Supplied in an acid-proof plastic box, which is also excellent for subsequent transport.

ABICLEANER Signature Set

Pos.	Description	Part-No.
13	ABICLEANER Signature Set, complete (1 pc.)	192.0402.1
14	ABICLEANER Signature Fluid, 100 ml (1 pc.)	192.0403.1
15	ABICLEANER O-rings (10 pcs.)	192.0406.10
16	ABICLEANER Signature Pads (10 pcs.)	192.0407.10



COOLANT RECIRCULATORS

CR 1000 ■ CR 1250

For a “cool” welding process ...



In high amperage applications with long welding cycles gas cooled torch systems can reach their limits. This can lead to malfunctions and unnecessary downtime.

The mobile cooling units CR 1000 and CR 1250 are the ideal complement system to equip a power source designed for gas cooled welding with a liquid cooled welding torch. For a permanently “cool” welding process. The devices are characterized by their high cooling performance in a compact design and easy handling.

With a few steps the integrated flow switch* for the permanent monitoring of the complete cooling system can be connected to the machine-side connection of the welding torch. Therefore, operation without coolant is not possible and the welding torch as well as the cooling unit are optimally protected.

- High cooling performance in a compact design is ideal for mobile use
- International quick connectors for easy, time-saving installation
- Integrated flow switch for the permanent monitoring of the complete cooling system for protection of the welding torch and the cooling unit – connection set included in delivery
- Exposed tank with coolant level indicator for convenient filling and draining of the coolant
- Overheat protection for pump and motor – for a long life
- Low-weight and sturdy carrying handles for easy transport to the job location
- Splash-proof fuse, main switch and louvers

*Operation is also possible without flow switch

Technical data

Technical data	CR 1000	CR 1250
Heat exchanger	2-row	3-row
Supply voltage	230 V AC / 50 Hz	230 V AC / 50 Hz
Pump 50 Hz	Flow rate Q_{max} 7 l/min	Flow rate Q_{max} 7 l/min
	Delivery height H_{max} 35 m	Delivery height H_{max} 35 m
Pump pressure	3.5 bar	3.5 bar
Cooling capacity	1000 W with H ₂ O	1250 W with H ₂ O
	750 W with BTC-15**	1050 W with BTC-15**
Noise level at 1 m distance	67 dB (A)	67 dB (A)
Weight	14.9 kg	16.7 kg
Dimensions L/W/H	490/250/410 mm	690/250/340 mm
Tank capacity	6.0 litres	6.0 litres
Water connection	ND 5 (quick connector)	ND 5 (quick connector)

**The coolant BTC and BTC NF of ABICOR BINZEL protects liquid cooled welding and cutting torches as well as cooling devices by their very low conductance of < 4 µS/cm against electrolytic corrosion and premature wear.

Coolant recirculators cpl.



Pos.	Description	Part-No.
1	Coolant recirculator CR 1000	850.1001.1
2	Coolant recirculator CR 1250	850.1051.1

NOTES

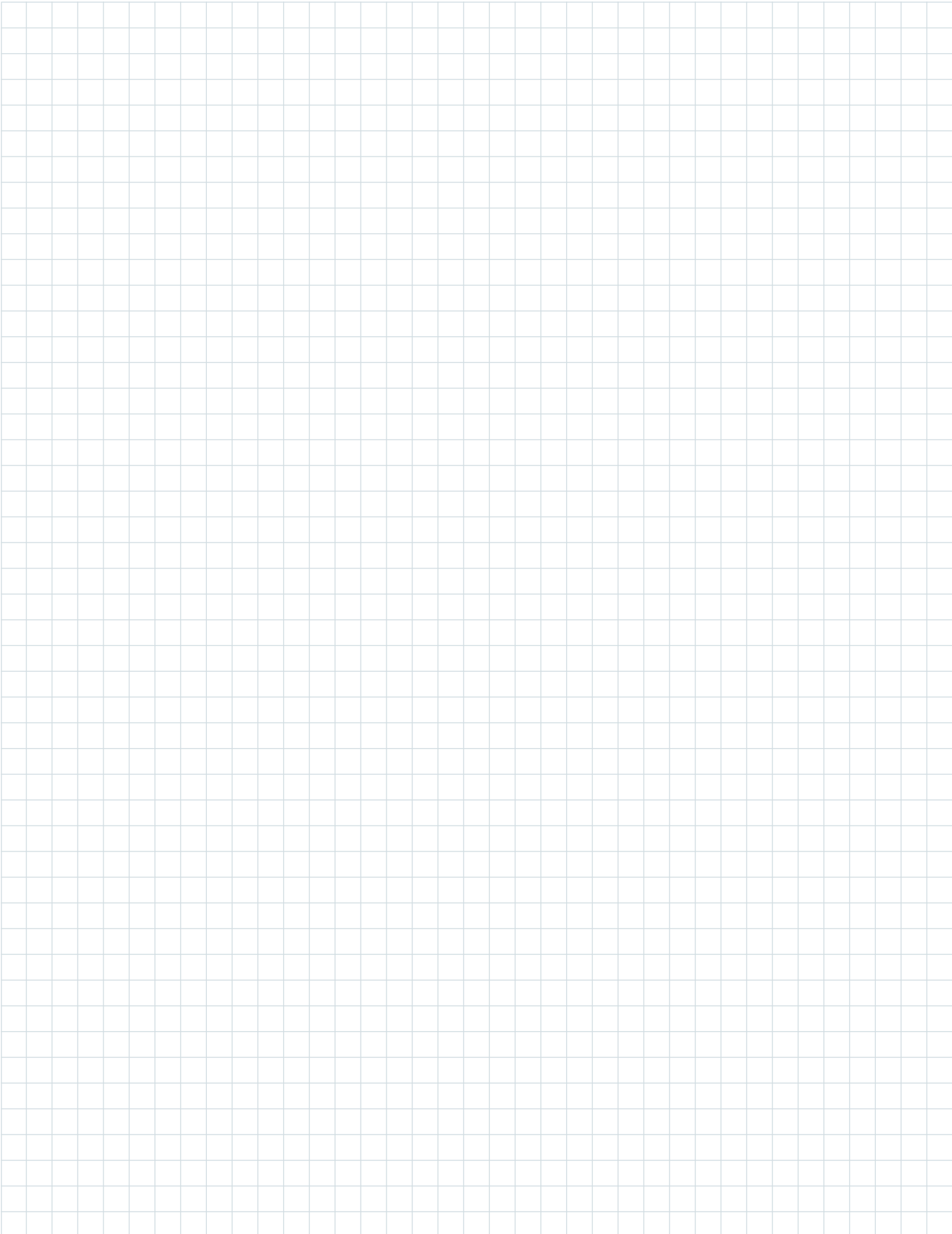

NOTES

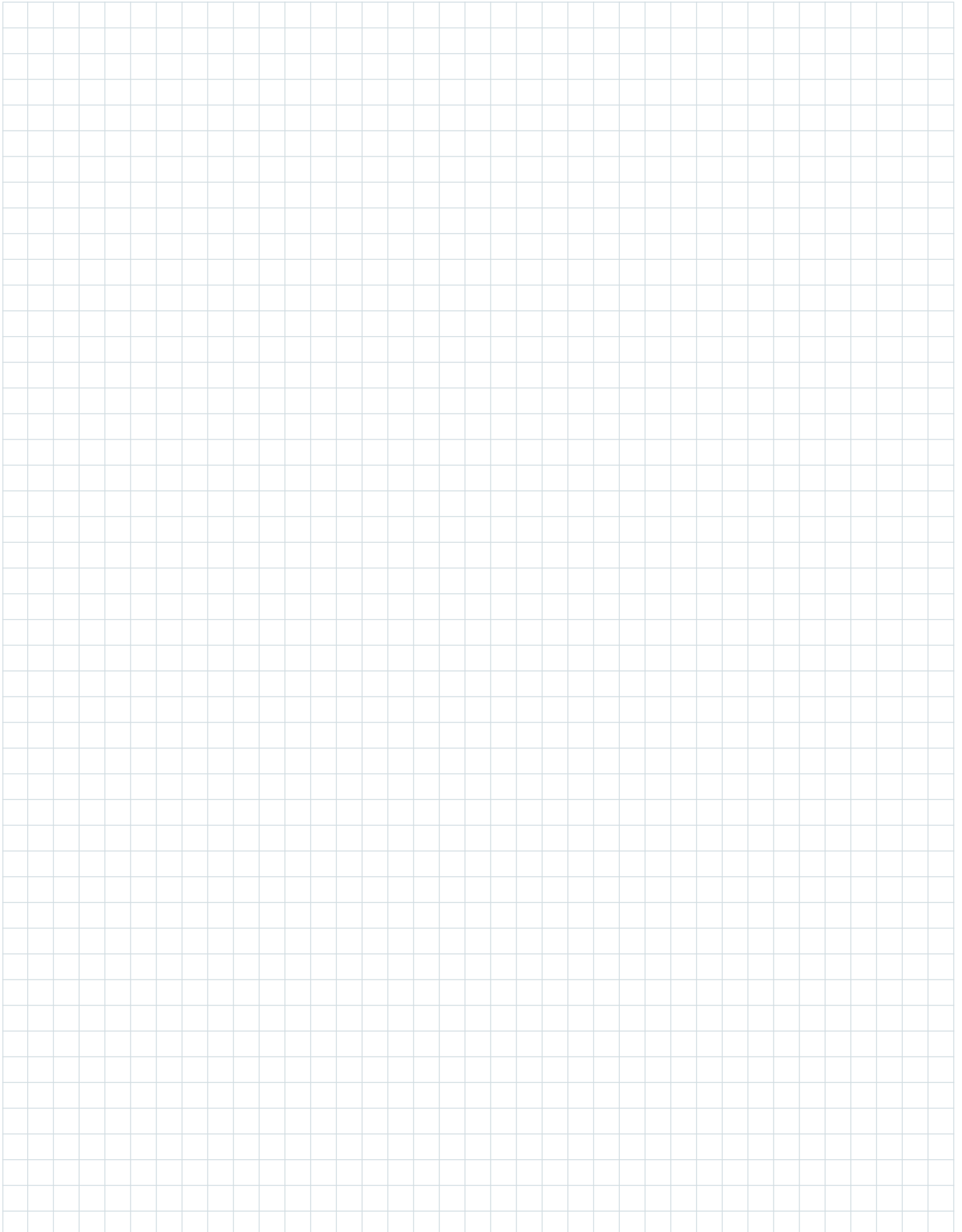

Our product range

MANUAL

- MIG/MAG welding torches
- TIG welding torches
- Plasma cutting torches
- Plasma welding torches

EXTRACTION TECHNOLOGY

- Fume extraction systems
- Fume extraction torches
- Fume extraction & power source combination system

ROBOTIC SYSTEMS

- Robot torches MIG/TIG/Plasma
- Robot switch-off protections
- Torch cleaning stations
- Wire cutting devices
- Robot power source
- System solutions for cobots
- Pipe welding robot
- Wire feeder systems
- Seam tracking sensors
- Gas management systems

LASER SYSTEMS

- Remote laser scanner
- Tactile laser optics
- Wire feeder systems
- Process monitoring tools
- Weld seam inspection

ORBITAL WELDING

- Orbital welding systems
- Positioning bands
- Coated contact tips

HARD AUTOMATION

- Welding tractors
- Welding tractor & power source combination system
- MIG/MAG automatic torches
- Plasma automatic welding and cutting torches

WELDING ACCESSORIES

- Wear parts MIG/TIG/Plasma
- Intermediate cable
- Sockets and plugs
- Electrode holders
- Gouging torches
- Gouging electrodes
- Utilities and tools
- Cooling units
- Wire feeding units
- Equipment for weld seam treatment
- Anti-spatter agents, sprays and pastes



Alexander Binzel Schweisstechnik GmbH & Co. KG
 Kiesacker · 35418 Buseck · GERMANY
 T +49 64 08 / 59-0
 F +49 64 08 / 59-191
 info@binzel-abicor.com

www.binzel-abicor.com